

Free Source of Energy Technology

Future with Free Energy Concepts and Technologies, End of Oil and Energy Crisis, Global Warming, Air Pollution, Revolutionizing World and Saving Earth

Syed Mohammad Ahmed

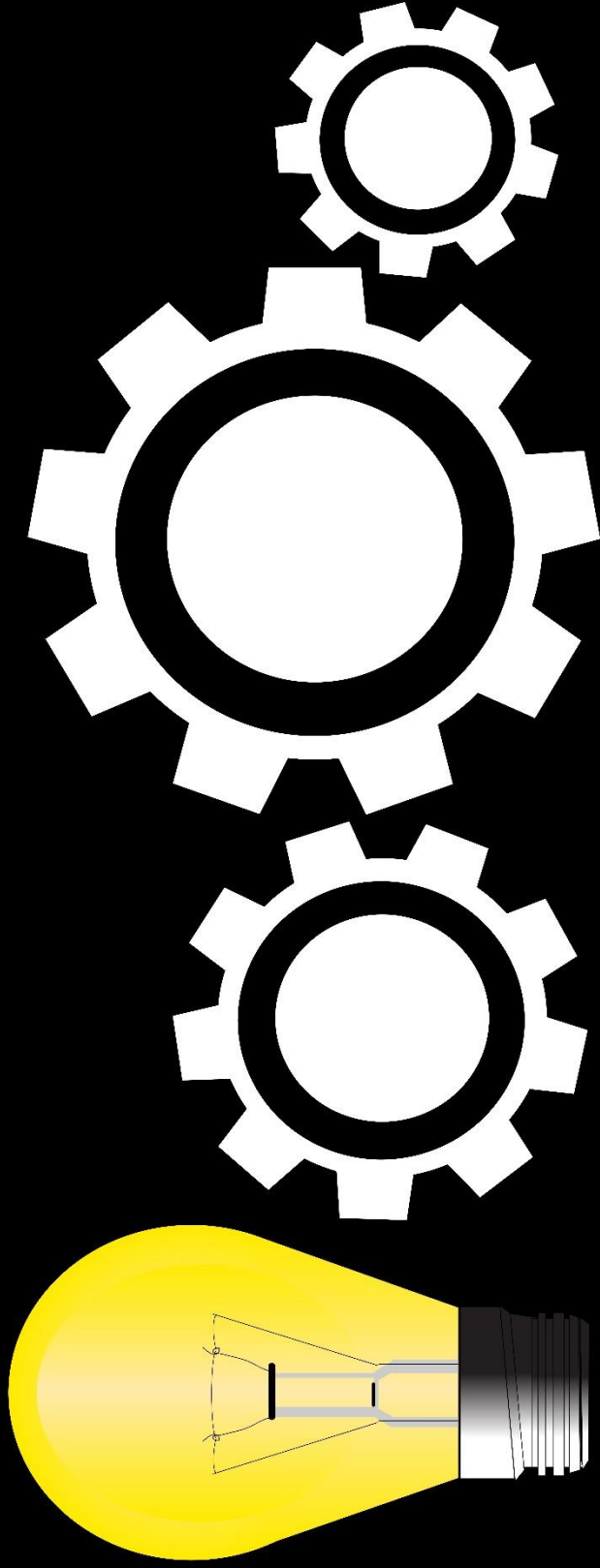

Free Source of Energy Technology:

Future with Free Energy Concepts and Technologies, End of Oil and Energy Crisis, Global Warming, Air Pollution, Revolutionizing World and Saving Earth

By

Syed Mohammad Ahmed

Table of Contents

Book Title.....	1
Table of Contents.....	2
Preface.....	11
Disclaimer.....	16
Copyright Notice.....	17
Intellectual Property Notice.....	18

Part 1

The Requirement and Necessities and the Impact and Future with the Innovation of Free Source of Energy Concepts and Technology.....	19
1.0 The Requirement and Necessities.....	20
1.1 The Innovation and Technology.....	22
1.2 The Impact on Economies & Industries.....	24
1.3 The Impact on Businesses.....	27
1.4 The Impact on Global Trading.....	32
1.5 Global Saving Per Capital Income.....	35
1.6 Reduced Cost of Energy.....	39
1.7 Easily Adaptive Energy Source.....	42
1.8 Impact on Oil Markets.....	46
1.9 Impact on Natural Reserves.....	51
2.0 Real Estate Infrastructure.....	55
2.1 Air Conditioners (AC).....	57
2.2 Impact on Innovation, Research and Developments.....	62
2.3 Impact on Infrastructure.....	64
2.4 Industry and Factory Infrastructure.....	66
2.5 Free Electricity for Factories.....	68
2.6 Factory Machinery.....	69
2.7 Cutting Machines Industry.....	71
2.8 Packaging Industry.....	73

2.9 Auto Industry	75
3.0 Automobile Factories	80
3.1 Electronic Industry	83
3.2 Toy Industry	85
3.3 Global Power Tools Industry	87
3.4 Lighting Industry	91
3.5 Portable Medical Equipment Industry	99
3.6 Urban Environment Planning	103
3.7 City Infrastructures	106
3.8 Carbon Free Cities	107
3.9 Lighting infrastructure	108
4.0 Real Estate Properties	112
4.1 Power Generators	113
4.2 Sensors	114
4.3 City and Building's Water Supply Infrastructure	117
4.4 Elevators and lifts	119
4.5 Heating, Ventilation, and Air Conditioning (HVAC) and Ozone Layer Protection	121
4.6 Telecom and Network Infrastructures	125
4.7 Network Towers	127
4.8 Traffic Management infrastructure	129
4.9 Roads	130
5.0 Radars and Sensors	132
5.1 Traffic Lights	133
5.2 Remote Control Devices	134
5.3 City Lighting and Decorations	135
5.4 Business and Real Estate	138
5.5 Home infrastructure	140
5.6 Lights at home	141
5.7 Electronics devices at home	142
5.8 Home Essentials Equipment	143
5.9 Home Appliances	144
6.0 Smart Devices	145
6.1 Business Units Infrastructure	147
6.2 Work and Office infrastructure	149
6.3 Transportation and Logistics Industry	151
6.4 Aviation and Aerospace Industry	154

6.5 Air Transportation Industry and Aviation Fuel Market	155
6.6 Aerospace Industry	158
6.7 Automotive Industry and Land Transportation.....	163
6.8 Marine Industry and Sea Transportation	169
6.9 Bunker Fuel Industry	173
7.0 Ocean Freight Industry.	176
7.1 Heavy Equipment and Machinery	178
7.2 Hydraulic Cranes and Water Pumps.	180
7.3 Smart Agriculture Industry and Farming	182
7.4 Fishing Industry.....	189
7.5 Courier and Global Delivery Market and Industry	192
7.6 Online Food Delivery Market and Industry	196
7.7 Retail Industry and Market	198
7.8 Banking Service Industry and Financial Market	201
7.9 Hospitality Industry	206
8.0 Education Industry.....	209

PART 2

How Free Source of Energy Can Solve Global Warming and Save Oil Reserves.	215
---	-----

8.1 The Technology	216
8.2 The Impact.....	218
8.3 Environment Friendliness.....	220
8.4 Carbon Free Planet	221
8.5 Ozone Layer Protection.....	225
8.6 Climate Friendly	226
8.7 Revolutionary Change	229
8.8 Technology Shift and Adaptability	231
8.9 Global Market Change.....	233
9.0 Impact on Oil Markets	234
9.1 Effects on Oil Consumption	235
9.2 Alternative Energy	237
9.3 Economy and Energy Sector	240
9.4 Banking Sector.....	241
9.5 Uses and Diversity.....	242

PART 3

How can Free Source of Energy Save Planet from Worldwide Carbon and Air Pollution?243

9.6 Introduction on Free Source of Energy Technology?	244
9.7 Why it is Important.....	245
9.8 Worldwide Carbon and Air Pollution Epidemic	250
9.9 Understanding the Epidemics	252
10.0 Air Pollution Born Issues on Human Population	255
10.1 Air Pollution Effects on Lifestyle	256
10.2 Air Pollution Caused Diseases.....	258
10.3 Deaths Caused by Pollution	259
10.4 Death Rate Worldwide	260
10.5 Global Warming Effects and Planet Earth's Health	262
10.6 Climate Change and Air Pollution is a Global Issue	266
10.7 Causes of Carbon Emissions and Air Pollution.....	269
10.8 The Ultimate Solution to End Global Warming and Air Pollution	271
10.9 Why the Free Source of Energy Technology is an Ultimate Solution?	272
11.0 Control on Carbon Emissions and Air Pollution	273
11.1 Free Energy an Alternative Energy Source	274
11.2 Less Cost of Energy	276
11.3 After-Effects of Ultimate Solution.....	277
11.4 Positive Effects on Worldwide Industries	278
11.5 Rise of Carbon Free Industries	279
11.6 Carbon Free Heavy Industries	280
11.7 Carbon Free Automotive, Marine, and Aviation Industries	281
11.8 Carbon Free Energy	283
11.9 Effects on Environment	284
12.0 Effects on Cities.....	285
12.1 Effects on Population.....	287
12.2 Effects on Atmosphere	289
12.3 Better Wild-life	290
12.4 Healthy Population	291

12.5 Clean Air	292
12.6 Effects on Climate	293
12.7 Effects on Planet	295
12. 8 Final Notes	296

PART 4

How Humans can Innovate Free Source of Energy Technology: Covering the Possible Strategy and Scenarios to Overcome the Ultimate Challenge.	305
---	-----

12.9 Introduction - The Science and Art.....	306
13.0 Belief in Science and Innovations.....	313
13.1 The Power of Belief.....	314
13.2 For Starters - The Two Important Parts of Creation	322
13.3 First Essential Part: Free Source of Energy Platform.....	326
13.4 Awareness and Publicity	328
13.5 Mission Vision and Objective	333
13.6 Unified Ideology.....	335
13.7 Global Invitations.....	337
13.8 - Billions of Innovators	338
13.9 - Millions of Brains Against Common Objective	339
14.0 Common Goal.....	341
14.1 Online Community.....	342
14.2 Public Participants.....	344
14.3 Participants Submission	346
14.4 Community Contribution.....	348
14.5 Concept and Research Contributions	350
14.6 Digital Rights Management.....	352
14.7 Patents Enrollment and Protection	353
14.8 Flexible Patent Registration.....	354
14.9 Project Support.....	355
15.0 Fundraise.....	356
15.1 Fund Contribution.....	358
15.2 Supervision and Management	359
15.3 Types of Offering.....	361
15.4 Licensed Works	362

15.5 License Subscriptions.....	363
15.6 Basic License.....	364
15.7 Advance License.....	364
15.8 Elite License.....	364
15.9 Affiliate Commission.....	365
16.0 Remuneration.....	366
16.1 Reward System.....	367
16.2 Royalty and Commissions.....	369
16.3 Creating the Right System.....	370
16.4 Free Energy Initiative Slogan.....	371
16.5 Fair and Positive Economy.....	373
16.6 Global Participants.....	376
16.7 All Nations Participations.....	377
16.8 Easy Accessibility.....	379
16.9 Website platform.....	380
17.0 Mobile App Platform.....	382
17.1 Universal Device Support.....	384
17.2 Understanding Innovation.....	385
17.3 Project Timeline.....	387
17.4 Prototypes Creation.....	389
17.5 Working Prototypes.....	393
17.6 Innovators Lab for Improvements.....	397
17.7 Better Versions and Upgradation.....	399
17.8 An Endless Innovation.....	400
17.9 Invite System for Progressive Continuous Improvements.....	401
18.0 Turning Vision into A Reality.....	403
18.1 Second Essential Part.....	405
18.2 The Concept and Idea.....	406
18.3 Motivation.....	407
18.4 Physics.....	409
18.5 Motions.....	411
18.6 The Mechanics.....	413
18.7 Tuning.....	415
18.8 Adjuster.....	416
18.9 Loop.....	417
19.0 Looper.....	417

19.1 Magnetic Looper.....	418
19.2 Force	420
19.3 A Powerful Magnet and Magnetic Force	421
19.4 Looper Lever Arms.....	422
19.5 Energy Motors or Power Motors	424
19.6 Energizer.....	425
19.7 Magnetizers.....	425
19.8 Energy Storage or Power-banks.....	426
19.9 Energy Hubs	427
20.0 Magnetic Wheel or Free Energy Wheel.....	428
20.1 Magnetic Wheel Propeller, Magnetic Shafts	429
20.2 Magnetic Plates, or Flat Magnetic Plates or Flat Plates or Flat Blades.....	430
20.3 Central Processing Unit (CPU)	431
20.4 CPU Functions.....	432
20.5 Software Management	433
20.6 Software Features	435
20.7 Operation Control Management.....	436
20.8 Brake Systems.....	437
20.9 Pause Operations.....	439
21.0 Schedule Start, Pause, and Stop.....	440
21.1 Smart Break Operation.....	441
21.2 Safety Stop Options	443
21.3 Emergency Stop	445
21.4 Emergency Start.....	447
21.5 Maintenance Mode.....	449
21.6 Disassembling Machinery	450
21.7 Assembling Machinery	451
21.8 Boot Operations.....	452
21.9 The Research	453
22.0 Gathering Information.....	455
22.1 Progressing to the Development Stage	457
22.2 Team Building	458
22.3 The Development.....	460
22.4 The Mechanics	461
22.5 The Engineering	463
22.6 Modelling the Prototype.....	464

22.7 Resourcing	466
22.8 The Project Structure.....	468
22.9 The Plan and Execution	469
23.0 Experimenting.....	471
23.1 Possible implications	473
23.2 Expectations.....	475
23.3 Improvements	477
23.4 Improving the Designs.....	478
23.5 Improving the Qualities.....	480
23.6 Goals and Milestones	482
23.7 Reaching Goals	483
23.8 Improving Standards.....	484
23.9 Project Building Stages	485
24.0 Project Deployment Stage	487
24.1 Project Finishing Stage	488
24.2 The Final Results	489
24.3 Reaching the Milestone.....	490
24.4 Media Support	491
24.5 Renovating the Existing Product.....	492
24.6 Feedbacks	493
24.7 Collaborations	494
24.8 Working on the better versions	495
24.9 Stable Product Development.....	496
25.0 Ready for Public Usage	497
25.1 Identifying the Market Size	498
25.2 Meeting the requirement	500
25.3 Closing the market gaps	501
25.4 Working towards the future vision	502
25.5 Opening doors to the new era of modern technology	503
25.6 Free Energy Engines and Machines	505
25.7 - 1 Looper Engine Free Energy Machine	506
25.8 - 1 Looper Engine Free Energy Machine in-action elaboration.....	507
25.9 - 1 Looper Engine Free Energy Machine model pictures.	509
26.0 - 3 Looper Engine Free Energy Machine	511

26.1 - 3 Looper Engine Free Energy Machine in-action
elaboration..... 512

26.2 - 3 Looper Engine Free Energy Machine model pictures.
..... 514

26.3 - 4 Looper Engine Free Energy Machine 516

26.4 - 4 Looper Engine Free Energy Machine in-action
elaboration..... 517

26.5 - 4 Looper Engine Free Energy Machine model pictures.
..... 519

26.6 - 2 Wheels, 1 Looper Engine Free Energy Machine 521

26.7 - 3 Wheels, 1 Looper Engine Free Energy Machine..... 521

26.8 – 2 and 3 Wheels, 1 Looper Engine Free Energy Machine
in-action elaboration 522

26.9 - 2 Wheels, 1 Looper Engine Free Energy Machine model
picture 525

27.0 - 3 Wheels, 1 Looper Engine Free Energy Machine model
picture 526

27.1 – Important Free Energy Engine Machine Features..... 527

27.2 - About Author..... 533

27.3 Book Summary 534

27.4 – Index..... 538

Note Page..... 557

Readers can create a bookmark if necessary 559

Intentional Empty Page 560

Preface

To everyone who is about to read my book, my name is Syed Mohammad Ahmed, and I am the author of this book, I would like to say that this book has been one of my biggest aspirations, and the cause is one of my biggest goals of life, and the ideas and concepts written in this book has been protected by me for around 17 years, as I came up with the concept in my early teenage, I remember the day this concept was first conceived by my mind, I do not remember the exact date but, I was preparing for some regular school test, and while sitting on a dining table, I saw clips over the television about the poverty in Africa, I was shocked to see the devastating imagery of humans living in unbearable conditions, and some of the things that I saw that day was, extremely thin people in some African tribes, badly malnourished children due to food shortages, and lack of electric power, and huts made of unstable walls, no modern infrastructure was shown, however the

things that mostly raised an eyebrow was the lack of power facilities, and insufficient agriculture resources, the poor African tribes did not had any kind of power connection, and households so unfortunate that listening to a semi-broken radio device was their only mode of entertainment, and the only one thing that fascinated me was the radio they were using, I felt extremely sympathetic about their situation, yet was a bit curious to see that, they were using a manual radio device, that does not had any batteries or power-cable, but a manual hand operated power paddle, and it was like the ones you see on a bicycle, but smaller for a single hand usage, it did not seem to make a big difference, yet people were happy to have such an entertainment instrument, however it seemed like a pure workout, and I was wondering that people cannot perform 20 bicep curls in a gym, and there those poorly malnourished guys somewhere in Africa, has enough stamina to make the device run for hours.

The experience made me very emotional, and tears were in my eyes, and felt very sad to see something of that nature, following the end of the clip, the innovative part of my brain was triggered and I started creating a mechanical device in mind, that does not need any kind of external power-source, at those times, I, was used to learning the 3Ds Max software at home, and sometimes had drawn some 3D objects like, a flower vase, a castle on sand, and interior of a house, however when my brain started creating the Free Energy Device, I, created a workspace like 3Ds Max in my mind, and started generating a mechanical model from scratch, it was so sophisticated, and I do not remember the exact details after more than a decade, however, I came up with other ones, that according to me has greater potentials of generating Free Energy Electricity at a very large scale.

This book is completely written by me, and every sentence is the result of my thinking, however, some numbered facts were collected from sources that were already

public, and those sources are mentioned in the index, and some of the important things that I, like to mention are that, this book is written using simple word choice, and anyone with the basics of English language can easily read the book and understand it, the page numbering is done in the middle for the convenience of the readers because many times the pages get torn from the sides for various reasons, and the paragraph numbering is done innovatively, and the book has extra pages in the end for useful purposes, as one page is dedicated for writing notes, and other for creating a bookmark for readers with scissors-cut-marks.

I would like to say that, this book is a part of my online project and platform and will be available at freesourceofenergy.com, and this is my first step as a trailblazer, that has an intention of revolutionizing the world, and saving the planet from anticipated events of Climate Change, Global Warming, Oxygen Depletion, Air Pollution, and Oil and Power Crisis.

I hope, that my book will trigger the innovator inside the readers, and shall open doors to the new world of opportunities for them, in the field of Free Energy.

The "Free Source of Energy Concepts and Technologies" in this book's context can be called and has the same meaning as of the terms "Free Energy or Free Energy Technology" as an alternative terminology and short abbreviation.

Disclaimer

All data is collected from reputable sources, but no reports are 100% accurate, because the future projections cannot be 100% accurate in any industry, due to unforeseen events, and the circumstances associated with different markets, trends, data, and human behaviors globally.

Copyright Notice

This book is the intellectual property of its author, thus protecting is essential and this book is 100% plagiarism-free, and every word, sentence, and concept that are written inside this Digital Format, eBook, Paperback, Hardcopy, or Book comes from the author's mind and is the result of his natural thought process. You cannot copy or create derivative and similar works from the contents and materials of this book without written permission from the original author, however, you can print the eBook version if you have legally downloaded it from a genuine source for yourself only.

Intellectual Property Notice

This book is the intellectual property of Syed Mohammad Ahmed, who is the sole owner and author of this book, and all the concepts, materials, and ideas given, written, and mentioned are the intellectual assets of its author, and owning and purchasing this book gives you no special permissions or any rights to utilize any concepts, ideas or part of this book without the written permission of original owner and author, You cannot utilize any idea or concepts in this book for commercial purposes or for profit, but can use them for non-profit or experimenting purposes. This book will enrich the readers with the knowledge and give them perspective over Free Source of Energy Concepts and Technologies (Free Energy Technology or Techs). However, you are not allowed to copy the exact models, concepts, and ideas for the sake of commercial reasons or profit without written consent, but you can come up with your own unique concepts, thanks to this book.

PART 1

The Requirement and Necessities and the Impact and Future with the Innovation of Free Source of Energy Concepts and Technology.

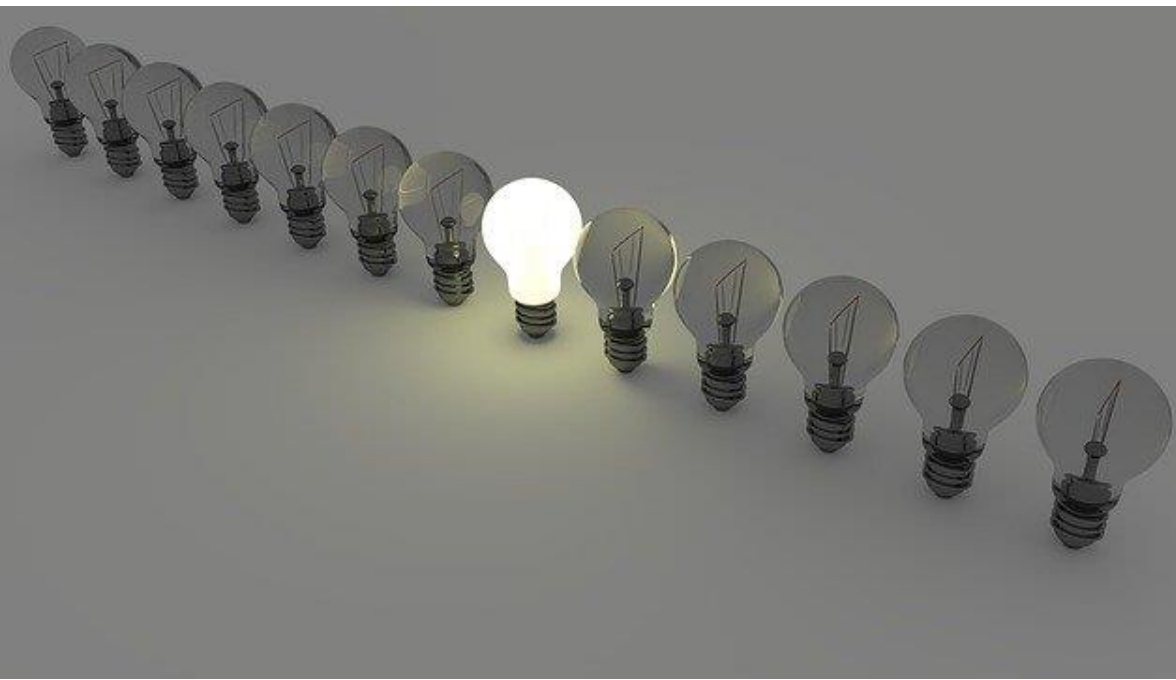

1.0 The Requirement and Necessities

There are more than 7.8 Billion People in the world, the human race has grown from 1 billion to 7.8 Billion in 200 years, the ever-growing population thus has non-stop requirements and necessities to keep up with the modern life they desire and energy has become one of the most demanding and vital parts of human life, whether it is a light bulb, air conditioner or your smartphone, the people living in the modern world just cannot live without the source energy such as the electricity.

The rise in economic development worldwide has increased the demand and consumption of energy to the highest level, whether it is your home, business, or a local manufacturing unit, everyone just needs electricity to properly run their operations. The worldwide immense demand is close to 22.3 trillion kilowatt-hours, and generating this kind of massive energy requires a lot of resources such as Coal 27%, Natural Gas 24%, Hydro

(renewables) 7%, Nuclear 4%, Oil 34% and other forms of Renewables which account for 4%.

World Energy Expenditures has doubled from 1990 to 2010 from US\$2,700bn to US\$6,400bn, and that's a staggering 6.4 Trillion US Dollars, thus this means that producing energy at mass scale is very costly but this is not the only reason why the Innovation of Free Source of Energy is ultimate requirement and necessity of the 21st century and the future of the world.

The world not only needs an inexpensive and a more reliable source of energy but they also require something very safe and super cost-effective and that which can prove to be cheap enough for not only the developing countries but the under-developing and for the poorest of nations worldwide.



1.1 The Innovation and Technology

Building a Free Source of Energy is not a miracle and the type of technology, that can do the job will be created with Vision, utmost discipline, willingness, and deep interest, and how can humans build a free source of energy will be elaborated and shared in part 4 of this book but before you

read that part you may also need to read all the preceding parts such as part 1, part 2, part 3, Jumping and skipping to the part 4 which is the last part may create confusion and you may not get the clear ideology of this book.

Imagination is one of the most powerful senses that all humans have thus to entertain your imagination and to unlock the right methods for innovating the Free Source of Energy it is recommended to read the entire book because otherwise, your mind may not get the idea the way I Syed Mohammad Ahmed as the author want to convey and you may not get my full message.

Before we jump into How to Build Free Source of Energy it is Vital to understand the impact it will have on the world and what type of futuristic applications will benefit from this type of innovation.



1.2 The Impact on Economies & Industries

According to The Global Industry Classification Standard (GICS), there are 11 sectors, 24 industry Groups, 69 Industries, and 158 Sub-Industries in the world, Each industry heavily relies on energy such as electricity for running their

operations and production, and not only the worldwide industries require electricity to manufacture, produce and operate their products and services, but the final products of these industries also rely on electric energy, for example, a smartphone manufacturer may require massive electric energy from some source to mass-produce the smartphones from their manufacturing units, as the machines operating in these units demands high electricity but the ultimate consumers may also require electricity to make the battery-operated device to work, and the same goes for all the other industries around the globe.

The Global Gross Domestic Product (GDP) for the year 2019 according to Statista is 142,005.65bn International Dollars, that's a staggering 142 Trillion Dollars combined GDP, and according to the world bank the World GDP for the Year 2019 is US\$87,698bn (US\$ DOLLARS) and that's a staggering 87.698 Trillion US Dollars.

Why does the given data is important because the prosperity of every economy in the world depends on energy and without that particular resource no nation in the world can create even the fraction of the Gross Domestic Product (GDP), thus creating a Free Source of Energy will help every nation including the top economies and those which are the poorest.





1.3 The Impact on Businesses

Every Business in the world requires a source of electricity to operate, and electricity is not only needed to run business operations but is needed to make the final products work, but that is not only the reason why a Free Source of Energy is required, but the main benefit we humans

on this planet earth will get from a Free Source of Energy is also the ultimate next level of innovation, which will change the image of the world towards the nano age, Free Source of Energy will revolutionize every aspect of modern technology in the world.

The Reason why Free Source of Energy will be the greatest achievement of mankind is that it will be used on every modern technological application on the planet, no matter the type of technology, every business in the world will start to transform their product and services by using the Free Source of Energy.

Impact of Free Source of Energy will be so great that the world will forget the preceding methods of energy such as batteries, Chargers, or power-banks, Yes these things will come in the package as an extra utility for the device, and as a backup plan, but the primary source of energy will be the ones which does not end and have an infinite supply.

The best part of building a Free Source of Energy will be the infinite supply of energy in the form of electricity, which means people no longer be needing batteries to make their devices work, as the Technology of Free Source of Energy will alone be used as an energy supply component for the device to make them work.

Free Source of Energy will be used in a vast varieties in all kinds of technologies worldwide, whether it is your radio, mp3, smartphone, or home, office, car, or bike, or kitchen appliances, the Free Source of Energy will be used everywhere and in every type of infrastructure on the planet.

Infrastructures worldwide will dramatically change, as the economies on the planet earth will be converting their existing power supplies into the Free Source of Energy, that means all the old infrastructure on the planet earth will be transformed into a new shape and model, that does not require electricity from the sources for which, the

people, will need an external electricity connection or pay any related bills or electricity usage charges.

Free Source of Energy, really means a free source of energy, and that means, the people, who will be using all those products and services that have Free Source of Energy' technology, feature or components in them as a built-in technology, will no need to pay for energy consumption such as for the basic needs and necessities like, home, car, smartphone, kitchen appliances, tv or anything which uses energy.

Everything and every product and service on the planet earth, that uses a form of electricity as a primary energy source, will be replaced by the Free Source of Energy Technologies, and that will result in a new modern world where economies will not rely on those sources of energies, which were used to be highly expensive to obtain, acquire or just use.

The factories and industries worldwide, that currently mass produce batteries will be changing their business models, and will start mass-producing Free Source of Energy Devices for sustaining in the competitive world of Free Source of Energy Technologies.





1.4 The Impact on Global Trading

The global export volume of trade in goods for the year 2018 was \$19,453.36bn (US BILLION DOLLARS) according to Statista.com, that's a staggering 19.453 Trillion US DOLLARS, Every product and service and trades in the world are depended on energy, let's assume a cargo ship which needs to transport merchant goods from destination A to destination B, everyone knows that the cargo ships require a lot of bunker fuel to work, the

bunker fuel market in the year 2017 was valued at \$137,215.5 Million Dollars or \$137.215bn (Billion Dollars) and is expected to reach a market value of \$273,050.4 million dollars or \$273.5bn (Billion Dollars) by the year 2025 according to alliedmarketresearch.com.



Consider that some markets such as bunker fuel will see a drastic decline in sales if a Free Source of Energy is

developed and adopted by the Marine Manufacturers as a primary non-fuel technology for their manufactured cargo, and other marine ships. That means a loss for bunker fuel markets, but a significant gain for the utilizers of the marine products as in the future, the owners of Marine and cargo ships will no longer be needing to acquire bunker fuel for operating their ships, thus, if every cargo ship in the world starts running on Free Source of Energy Technology, then the result will Trillions of dollars saved on fuel purchases, means no ship owner will ever need to pay for acquiring bunker fuels to run their ships, thus, it will save the marine Industries, and cargo trades, not millions or billions, but trillions of dollars on a global scale.



1.5 Global Saving Per Capital Income

The worldwide combined electricity consumption for the year 2014 was 21,776,088,770,300 (KW-h/yr) with an average power per capita of 2,674 Kilowatts (per person annually) according to one source on Wikipedia, power is priced differently globally but if we measure the cost at higher to lower end for the

worldwide combined consumption of 21,776,088,770,300 (KW-h/yr) for the year 2014 alone then we get the actual cost, according to the Germany standards as US\$ 7,186,109,294,199 (US Dollars), that's a staggering 7.186 Trillion dollars at the highest end because 1 Kilowatt costs \$0.33(US Dollars) in Germany and for the lowest end the cost would be US\$ 2,177,608,877,030 (US Dollars) a staggering 2.177 Trillion dollars according to the Argentina Standards where the cost per Kilowatts is \$0.1 cents according to the statista.com.

In reality, the actual cost differs as we have only calculated the cost for two extremes as one the highest and the other the lowest but in reality, the cost and the actual figure will be completely different than the scenario in the previous paragraph, because each country worldwide has very different electricity cost per Kilowatts, the preceding scenario was just to give a glimpse of what the actual cost may be if measure it against two extremes as highest to the lowest cost

for the electricity consumption for the year 2014 which was 21,776,088,770,300 (KW-h/yr).



If the Free Source of Energy model is adopted worldwide then that can save people thousands per household and nobody would ever be needing to pay for electricity bills thus that would save a staggering 7,186 Trillion dollars at the highest end and a staggering 2.177 Trillion

dollars at the lowest end annually, according to the calculations in the scenario on the previous paragraphs.

Remember that these figures and calculations are for explanatory reasons and not based on an actual cost for the year 2014, as each country has its own policies for electricity usage per kilowatts and actual charges may vary, even if the actual numbers differ one fact remains strong that the numbers for the cost, in reality, will be in Trillions of Dollars for the worldwide combined electricity consumption for the year 2014 which was 21,776,088,770,300 (KW-h/yr).



1.6 Reduced Cost of Energy

Electricity plays a very vital role in the progression of economies around the world, for the year 2018, the global access to electricity by population was around 89.589% (% of Population), according to data.worldbank.org. Electricity is the primary utility that has made the lives of billions of people on the planet earth easy

and comfortable, it is an absolute necessity, and one cannot do much without access to this form of energy, it has become a vital and most prominent need on which every aspect of human life depends on.



In a developed country like the United States, the average residential electric bill was \$111.67 in 2017 for roughly 132.6 million electricity consumers, according to

one article on financeguru.com. Electricity is not granted, and people have to pay for the total usage of this utility, and in the poorest countries of the world, people cannot afford electricity as it is one of the primary household expenses for which people living in poor nations like Africa, Pakistan and India have to sacrifice a lot.

Free sources of energy will privilege everyone on planet earth because people will no longer be needing to pay for electricity and this utility will become a granted thing for every household in the world. With the Innovation of the Free Source of Electricity, each household will be saving thousands that are spent annually as an aggregate of monthly electric utility bills.



1.7 Easily Adaptive Energy Source

Currently, the cost of a single unit of nuclear powerplant is extremely expensive and that can cost several billion US Dollars and a very long construction period. The construction cost varies in different countries but according to some articles on the web, it can cost from 2 to 23 billion

dollars or more for a single unit. Nuclear Powerplant is not only the modern technology that costs heavily but on the other side, the wind turbines units do also cost billions of dollars not only for a big but small urban city. A commercial-scale Wind Turbine may cost around 3 to 4 million installed, and a utility-scale may cost 1.3 to 2.2 million dollars per Megawatts installed according to windustry.org.





A Wind Power in a developed country like the United States has increased its total nameplate generating capacity to 107,433 MW in the year 2020 according to wikipedia.org, assume the total combined cost for each utility-scale unit per megawatts for the United States from low to high would be around US\$ 139,662,900,000bn to 236,352,600,000bn (US billion dollars).

The Free Source of Energy will be so adaptable and cost-effective, that every nation on the planet will plan to implement it, for their residents and shall consider discontinuing existing powerplants, or else keep them as a backup plan for unforeseen emergencies, it will be highly cost-effective and a must-have for every country on the planet earth, and ultimately all nations around the world will have no other choice than to build a Free Source of Energy's Powerplant as it will save the world Trillions of dollars spend on constructing other types of existing powerplant technologies.

Building the Free Source of Energy Powerplants will save not only billions, but trillions of dollars in a long term to each nation around the globe because people will no longer be needing to pay for it, except a voluntary tiny charge that will be accumulated for maintaining the technology.



1.8 Impact on Oil Markets

There were around 1.65 Trillion barrels of oil reserves on planet earth in the year 2016 alone, according to worldometers.info and the number is drastically declining. According to oilprice.com, the annual oil production is around 34 million barrels with an oil market size of \$1.7 trillion (trillion dollars) per year. The time this line in this paragraph was written on 04 September 2020, the oil left in the world according to

the worldometer.info was 1,498,061,991,000 barrels (1.498 Trillion barrels), so if the proven oil reserves in the world were 1.650 trillion for the year 2016 then it went down to 1.498 trillion barrels in the year 2020 that is a decrease of 152,523,149,000 barrels, that's a staggering 152.523 billion barrels in just 4 years, from the year 2016 to 2020.



This is a true fact that proven oil reserves in the world will run out someday due to the heavy consumption, according to ecotricity.co.uk, the global fossil fuel consumption is equivalent or around 11 billion tonnes annually, and all the oil reserves could run out in over 53 years, and may become a scarce resource in 2030 to 2050.



Free Source of Energy will have a huge impact on Oil Markets, as the entire world will start utilizing an advanced mode of energy, and a much more superior and better alternative to the existing power source technologies that require oil as a fuel source, such as for the cars, buses, marine ships, aircraft, bikes, motorcycles, heavy machinery or any other auto, machine or equipment that needs oil to operate and run.





1.9 Impact on Natural Reserves

Currently, Electricity production worldwide require an abundance of earth's natural reserves for generating electricity, according to Wikipedia the total global gross production of electricity was 25,082 TWh for the year 2016, the primary sources for producing this much electricity was 38.3% coal and peat, 23.1% natural gas,

hydroelectric 16.6%, nuclear power 10.4%, Oil 3.7% and other sources 5.6% such as solar power, wind turbines, tidal powered and some other, the remaining sources were biomass and waste which accounted for 2.3%.



Every Country in the world have to sacrifice a lot of natural reserves for generating electricity at their power plants, millions of kilotonnes of oil are used per hour globally

to meeting the required demand, according to Wikipedia the global total of energy consumed, for generating electricity at all power plants in the year 2008 was 51,158 terawatts per hour which were equivalent of 4.398,768 kilotonnes of oil, a 36% of total primary energy sources for the year of 2008.



The Free Source of Electricity will have a very big impact on Natural Reserves

worldwide and will help save the world's natural resources, all the countries in the world will prefer transforming their existing powerplant units into the Free Source of Energy that will not require any kind of natural reserves such as Oil, Gas, Coal, Peat, Nuclear Power or hydroelectric or any other which needs precious natural reserves to run.





2.0 Real Estate Infrastructure

Free Source of Energy will have a very positive and innovative impact on our existing and new infrastructures, the property owners will start upgrading their existing units for making them more compatible with Free Source of Energy, as it will reduce their electricity charges to zero.

The Landlords will have significant relief on utility bills such as for the electricity, all the existing electrical power sources will become obsolete and maybe used as a backup plan, the property owners and residents will start utilizing the Free Source of Energy technology for cutting their utility bills, and for saving money which was usually spend on electricity consumption.

Residential and Commercial Buildings will be powered by Free Energy Technologies, thus everyone living in apartments and those working in commercial space will benefit and enjoy the utilization of Free Electricity, all the devices, and electronics in these buildings will be powered by the Free Sources of Electricity.

Implementing free Electricity for Residents
The Impact of the Free Source of Energy will be so big dynamic that residents worldwide will enjoy a lifestyle in which, they will not be needing to worry about electric power as everything they own, will be powered by Free Energy Technologies.



2.1 Air Conditioners (AC)

In the Year 2020, only 4.8 billion people in the world had access to some sort of air conditioning unit, and the rest of the 2.6 billion people may not even have a proper cooling system, especially those parts of the world population, who are living in the countries with harsh and hot climate conditions, according to the www.iea.org.

The Air Conditioning market was valued at \$121bn (Billion Dollars) for the year 2017 and is projected and anticipated to further grow into \$231bn (Billion Dollars) by the year 2023, according to techsciresearch.com.

The Free Source of Energy will have a dynamic impact on all kinds of Air Conditioning products and will enhance and improve this industry's standards, as all the existing market leaders in this space will be needing to go into an up-gradation by transforming their existing technologies for making them compatible with the Free Source of Energy Technologies.

Air Conditioning Units will no longer be needing a power supply, and every kind of AC unit will be fully operational with Free Electricity, by having a special built-in component based on Free Source of Energy technologies.



In the future Air Conditioning manufacturers will start producing innovative and portable AC and Air Power units, which will be powered by Free Source of Energy technologies, and AC Products soon will consist of built-in or else an external component for generating free and infinite electric power supply, thus these types of AC products will help those

part of the world population, that lacks access to a proper Air Conditioning and electric power.



The incredible innovation of Free Source of Energy will give the unprivileged population of the world free access to electricity, and will also help the poorest nations around the globe by providing and handing them powerful free energy tools, that will help

them battle the worse kinds of climate conditions, and by making them acquire and obtain those types of cooling systems, which will not require any kind of expansive power sources, as the Free Source of Energy will provide them with an infinite supply of electricity for free, thus it will improve their living standards, and help them have a better sense and ease of life.

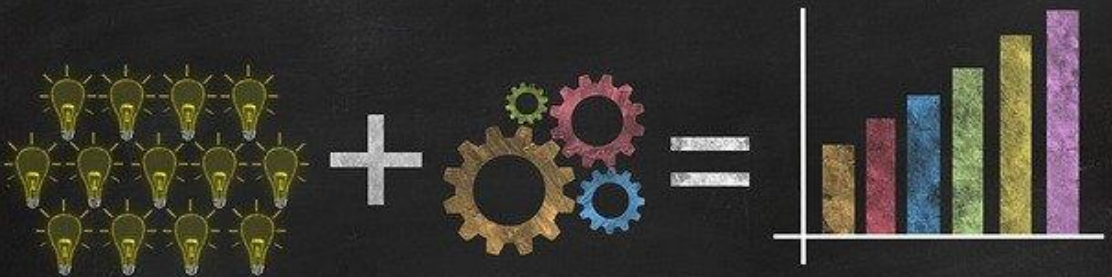

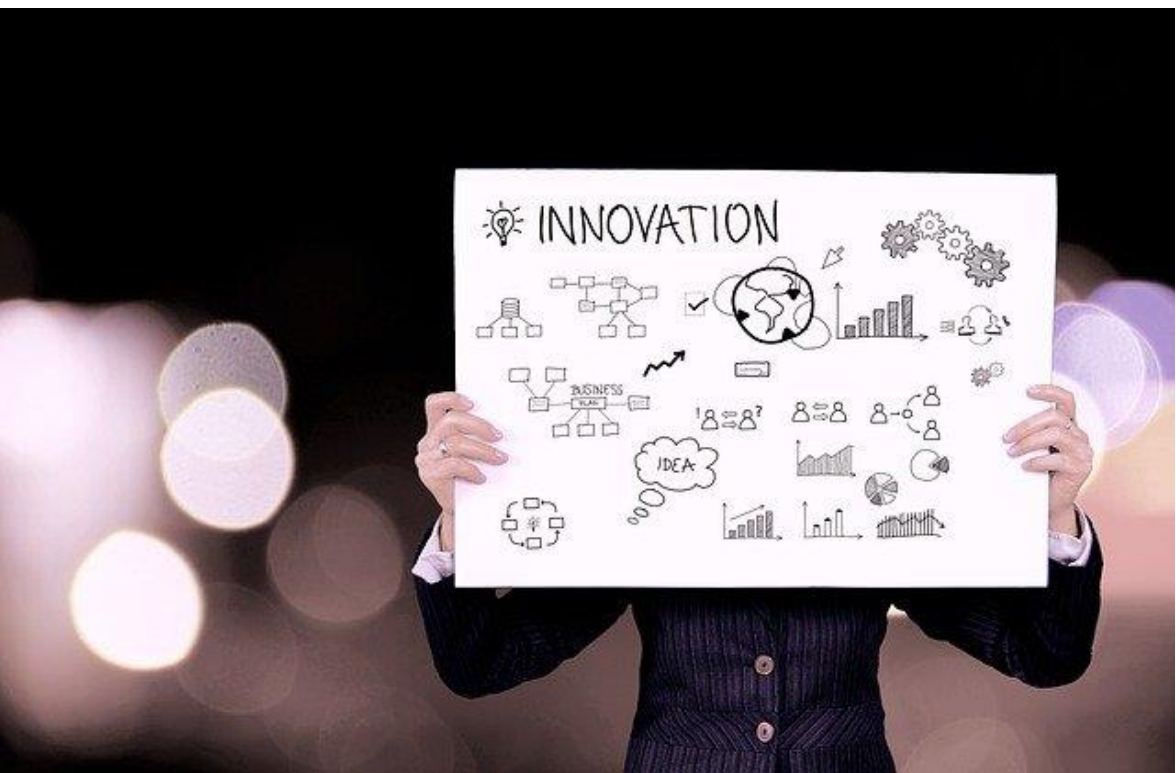

2.2 Impact on Innovation, Research, and Developments

The Free Source of Energy Technology will have a drastic and dynamic impact on global innovation, all the existing technologies will be upgraded to make them compatible and compliant with the Free Energy Techs, all the innovators from all existing and new industries will be driven to make futuristic and innovative products

and services, that will be fully compliant and compatible to run, operate and powered by Free Electricity Technologies, and that will be the ultimate future for advancements in systems and technologies, that will be invented and made by the breakthrough innovation of Free Source of Energy Concepts and Technologies.





2.3 Impact on Infrastructure

Due to the innovation of the Free Source of Energy Technologies, the Infrastructures globally will undergo major transformations which will enhance the lifestyle of all civilizations, people will stop buying stuff which does not have an integrated free

electricity power source components and features, and will start choosing all those products and services which will have a built-in infinite power source, this all seems like a fantasy for the future world but soon it will become the new reality for the human race, as in the near future electricity will be the cheapest utility which our new generations will take as granted and also benefit from.





2.4 Industry and Factory Infrastructure

The impact of Free Source of Energy on Industry and Factory Infrastructure will be immense, all the existing and new factories will soon begin improving their standards according to Free Source of Energy Schemes, different industries and factories world over will adapt a new business model for further increasing their revenue and for deducting their cost on manufacturing and production processes.

The Free Source of Energy will have a dynamic deep-level impact on production and manufacturing, as it will minimize the cost of production and improve the product and services through a modern application made by the Free Source of Energy Technologies.





2.5 Free Electricity for Factories

Free Source of Energy will provide free electricity to factories nationwide, thus, it will further increase the production by minimal electric outages, as an average factory pays lacs on electricity utility bills annually.

The Factories worldwide and nationwide will have enough electric power to fully operate their production units smoothly and

will help them save money that otherwise is spent on electricity consumption charges, thus it will give the factory owners peace of mind and further increase their savings.



2.6 Factory Machinery

All the Factory owners will start considering the utilization of Free Electricity Sources and will dynamically upgrade their existing

machinery units to be made compatible and compliant with the new standards and technologies of Free Source of Energy.

The Factory Machines will soon have their infinite power source components thus will improve the overall production capacity, directly and indirectly, due to the unlimited and more durable power supply with the least electric outages.

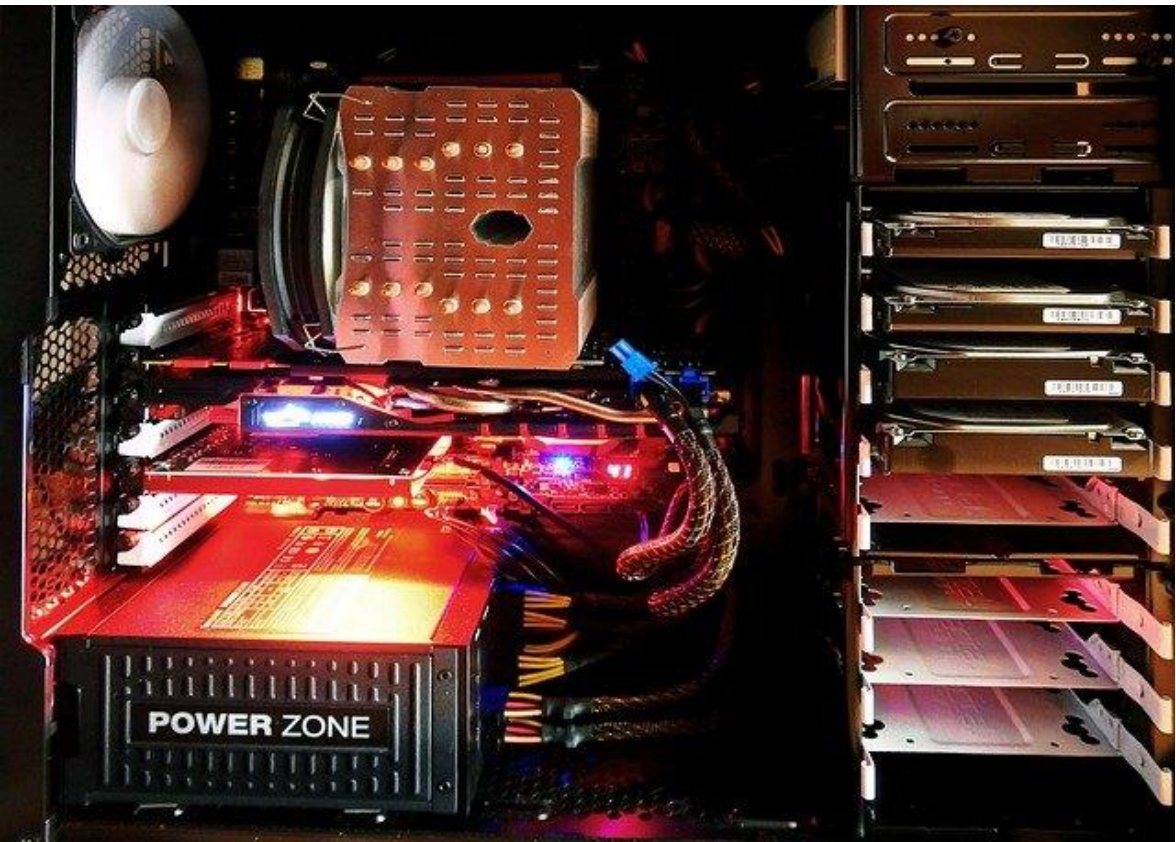

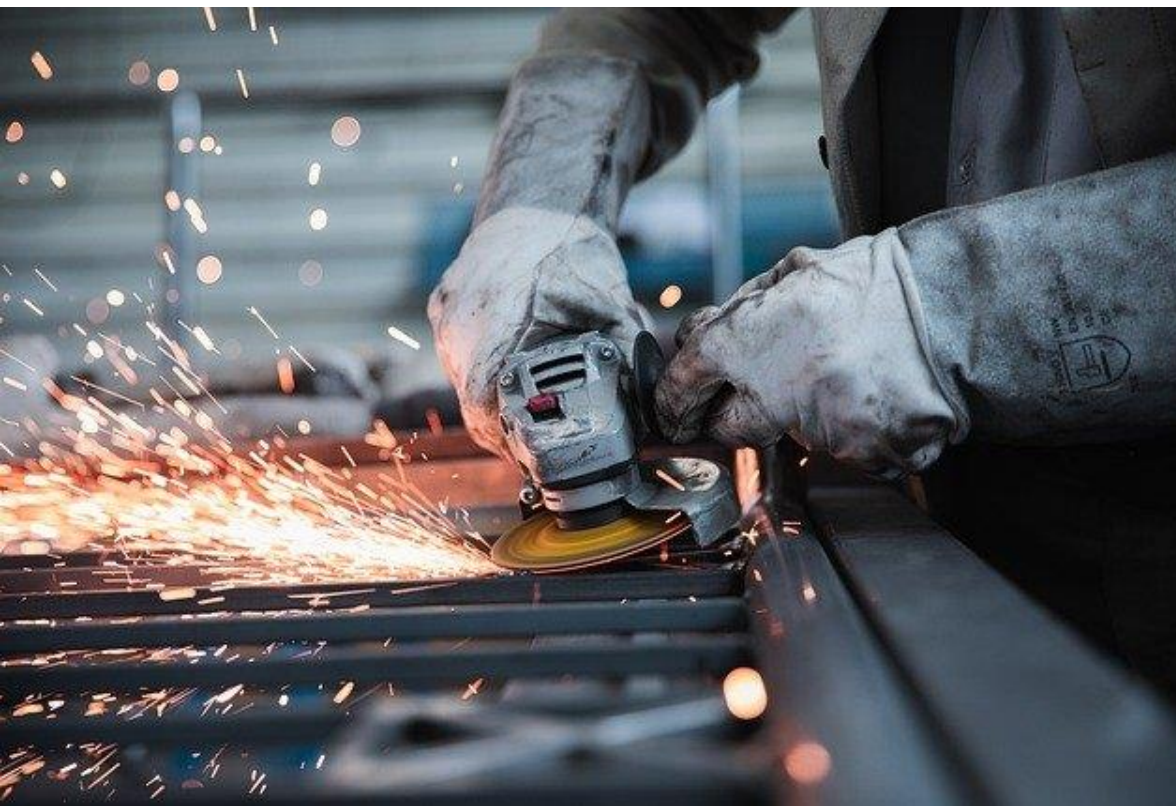

2.7 Cutting Machines Industry

One of the important tools for a factory is the cutting machines, different factories use a variety of cutting machinery whether it is for the purpose of cutting metals, plastics, glass, or anything entirely different, this market will be dynamically improved by Free Source of Energy as these machines will soon operate with Free Electricity

Sources thus will increase the overall usage capacity.

An average cutting machinery unit costs thousands of dollars annually and the overall cost may entirely depend on the volume of production, the higher the production time the greater the overall usage cost.

The global market size of metal cutting machines was valued at USD 6.17 billion dollars in the year 2019, according to grandviewresearch.com, and the global market size of laser cutting machines is anticipated to grow to \$5.7 billion dollars in the year 2022, according to alliedmarketresearch.com



2.8 Packaging Industry

The innovation of Free Source of Energy will, directly and indirectly, affect the packaging industry, the global market size for the packaging industry for the year 2019 was \$909.2 billion dollars and is anticipated

to grow to \$1012.6 billion dollars by 2021.

Factory packaging machines will no longer be needing to operate on a power source for which the factory owners need to pay high electricity utility bills, as an average packaging machine unit costs thousands of dollars per month due to high usage and consumption of electricity due to higher output demand.

An average packaging machine needs to run constantly all the time to meet the market demand, many factories operate simultaneously day and night to maximize the production and for increasing and matching the daily sales volume for optimal output.



2.9 Auto Industry

The Global Auto Industry was valued at \$5315 billion dollars (5.315 Trillion Dollars) in the year 2017 and is anticipated to grow into \$8931 billion dollars (8.931 Trillion

Dollars) in the year 2030, according to [statista.com](https://www.statista.com)

This particular Industry is going to be dynamically transformed and will be affected directly and indirectly due to the Free Source of Energy Technologies, the ultimate future of the auto industry will be the production of non-fuel cars that will have an infinite power source thus they will never run out of fuel and may not require fuels like petrol, oil and gas as their primary power source, the existing fuel types will become the backup plan for future vehicles as the majority of the auto consumers will start to own vehicles that consist of Free Electric Power Technology such as those based on Free Source of Energy Concepts.

All the major Auto manufacturers will start transforming their existing brands with the newfound innovation of Free Source of Energy Techs, as the new vision and goal for all the automakers will be the production of those vehicles that fully run, function, and operate on Free Energy, and be powered

by Free Electric Power Technology, which will be based on Free Source of Energy Concepts.



The Auto industry is one of the most successful and vital to any economy, because the progress of transportation and oil and gas sector directly and indirectly linked to the success of automakers worldwide, Autos are one of the major

imported and exported items and it is an absolute necessity for every nation, the general population heavily depends on some mode of transportation for their routine survival.

The number of cars sold globally is around 284.1 million units from the year 2010 to 2020, according to [statista.com](https://www.statista.com), and the number of motor vehicles that exist in the world was 1.015 billion units as of in the year 2010, and that number is anticipated to exceed 2 billion units in the year of 2035.

The innovation of Free Source of Energy will positively affect the Oil and Gas Reserves, but may negatively affect the oil markets in some regions, the increase in non-fuel vehicles will have a big impact on global oil and gas trade but that will positively affect the reserves because these natural resources are predicted to become a scarce resource by the year 2050 or more.

The production of non-fuel vehicles will help economies save and preserve their natural oil and gas resources thus the world will learn to sustain without consuming the natural resources for their own survival and monetary reasons.





3.0 Automobile Factories

This industry is going to be one of the major ones who will be the first to start innovating their products and services according to the concepts of Free Source of Energy,

An Auto Factory Requires many different types of fascinating technologies for mass-scale production, some of the important

ones are the automated manufacturing machines such as the factory robots like body paint robots, part assembling machines, engine testing facilities, heavy lifting machines, etc.

The Free Source of Energy will dynamically change the products and services in the auto industry and will save automakers an abundance of money which otherwise is spend on electric utility bills, the entire auto factory will operate on Free Energy Technology based on Free Source of Energy concepts.

Auto Factories are considered the largest factories in the world, Volkswagen Wolfsburg Plant, Germany is presently the largest auto factory and it is 6.5 kilometers square and has a capacity of manufacturing 3800 vehicles per day with an annual capacity of producing 815,000 vehicles annually.

All the Automakers will start the production of advanced non-Fuel vehicles, which will

become the new trend in the auto industry, all the existing auto models with its system and technologies will soon be transformed and advanced for making them more suitable and compliant with the advancements in the Technology of Free Source of Energy.

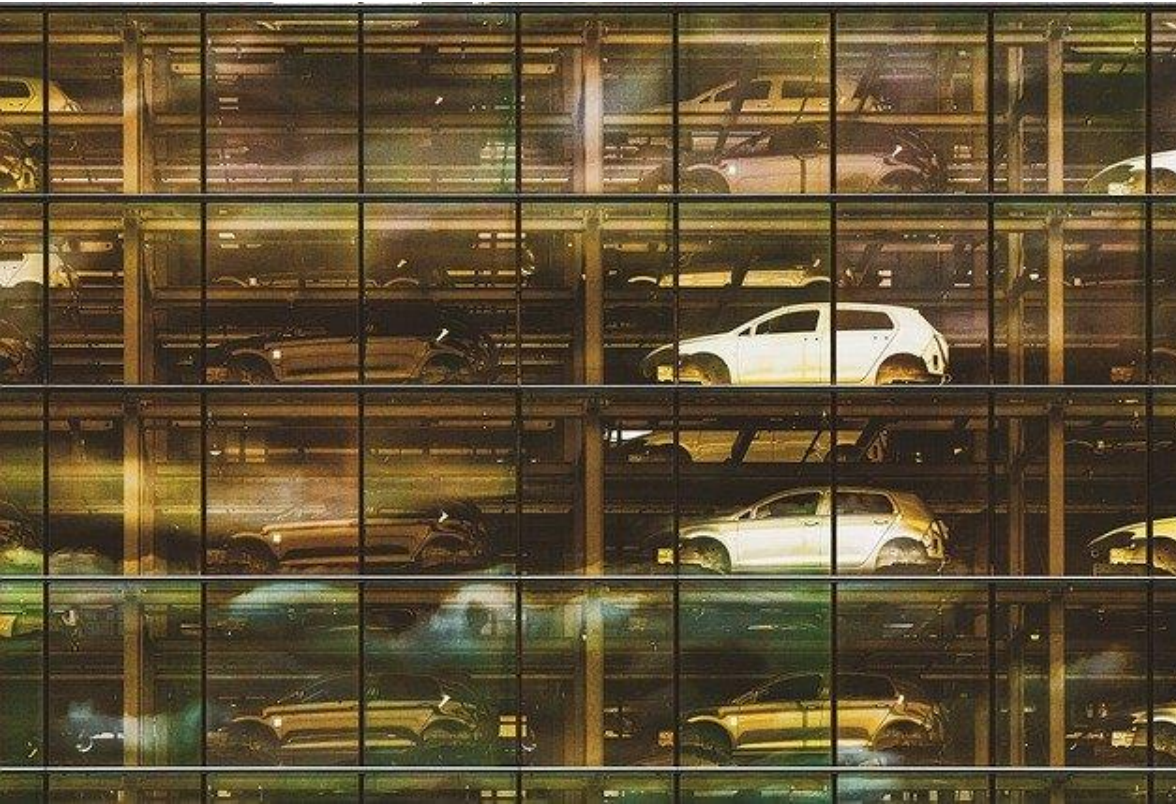



3.1 Electronic Industry

One of the major users of Free Source of Energy Technologies will be the global consumer electronic market, as all the electronics in the world will soon have a built-in or else an extra component for Free Electric Power Supply, thus that means most of the electronics will never run out of

charge and have a special power unit, that will be having the capacity of generating and supplying Free Electric Energy.

The Consumer Electronics Market was valued at \$1 Trillion dollars in the year 2019, according to gminsights.com, and the consumer electronic market is soon going to be a multi-trillion dollar market, over the next coming decades, as many consumer electronic companies will soon start to attain a status of being valued a Trillion dollar company, just like Apple Inc.

All the major Portable Electronic brands will soon start to design, manufacture and mass-produce those smart devices which will not require any kind of external and paid power sources for which the consumers need to pay money, like external batteries or home power plug utility.



3.2 Toy Industry

The Global Toys industry was valued at \$90.7 billion dollars in the year 2019, according to toyassociation.org, and the toy market is anticipated to grow into a \$120 billion dollars industry by the year 2023, according to researchandmarkets.com.

We all know that the present technological advancement has resulted in smarter

electronics and devices and for this reason the toys that the kids world-over play-with are becoming smarter and more innovative on a daily basis, thus in future the kids may be owning toys which will be a lot smarter and consist of an advance artificial intelligence and may also never run out of their power.

The advancements in the modern technologies of Free Source of Energy will affect all types of electronics and mechanical instruments and all those that require a stable source of power and Electricity, this means that the games and toys that the kids world-over play-with will have special components for an infinite power source.

Imagine your kids playing on a handheld gaming console that may not require any kind of battery replacements and runs on a free power source, this sounds like a very imaginary and kind of a movie fantasy thing, but this is going to be the new reality for the next generations of kids worldwide.



3.3 Global Power Tools Industry

The innovation of Free Source Energy is going to affect all the major industries which have products that are mechanically motorized and automated and consist of electric power sources to operate.

One of the major industries which are going to be dynamically impacted by the

innovation of Free Source of Energy is the Global Power Tools Industry, this industry type produces those machines and tools that are mechanically motorized and requires electric power to function and operate.

The Global Power Tools Industry market size was \$28.7 billion dollars in the year 2020 and is anticipated to grow to \$35 billion dollars in the year 2027, according to the [globeNewswire.com](https://www.globenewswire.com).

Every Major economy which manufactures and produces power tools are going to upgrade their existing technologies to make them more suitable and compliant with the Free Source of Energy Technology.

Imagine construction workers working on a project site and have tools that do not require an external power source, because they have their own infinite electric power unit based on the innovative applications of Free Source of Energy Technology.



Most Power Tools in the future will have a built-in power source component and some will have an external power unit device that will have an infinite supply of electricity and thus the power tools will never run out of power.

Many nations and civilizations currently lack a stable source of electric power and that makes their life very difficult, due to the

fact that there is no proper electric power source, these nations suffer a lot and that results in poor work progress no matter the type of business industry.





3.4 Lighting Industry

The Global General Lighting Industry was valued at \$102.5 billion dollars in the year 2019 and is anticipated to grow to \$148.7 billion dollars by the year 2023.

The Global LED Lighting Industry was valued at \$54 billion dollars for the year 2019 and is anticipated to grow to \$127.04 billion dollars by the year 2027.

The Free Source of Energy is going to impact all the lighting industries

dynamically, as in the future these industries will start manufacturing products and services according to the innovative and technological applications of Free Source of Energy Concepts.



All the major lighting brands will also soon start manufacturing those products which will not require any kind of external electric power, instead, they will have a build-in

component or else an extra unit that will comprise of infinite power supply.



Many new residential and commercial real estate developers will start constructing those buildings which will have special or dual power structure system installed, this way residents will be easily able to switch from one mode of power to another, as there will be an option to switch to Free

Source of Energy and use the other power modes as a backup plan.



The Global Lighting Industries world-over will be transformed dynamically, and all existing lighting products soon will become suitable and compliant with the technologies of Free Source of Energy.

The Common Household products like Light Bulbs are one of the technologies which will evolve into portable light bulbs, and all the indoor and outdoor lighting products will soon run-on Free Electricity, thus save the municipalities around the globe billions of dollars combined, that was usually spent on powering the city lights.



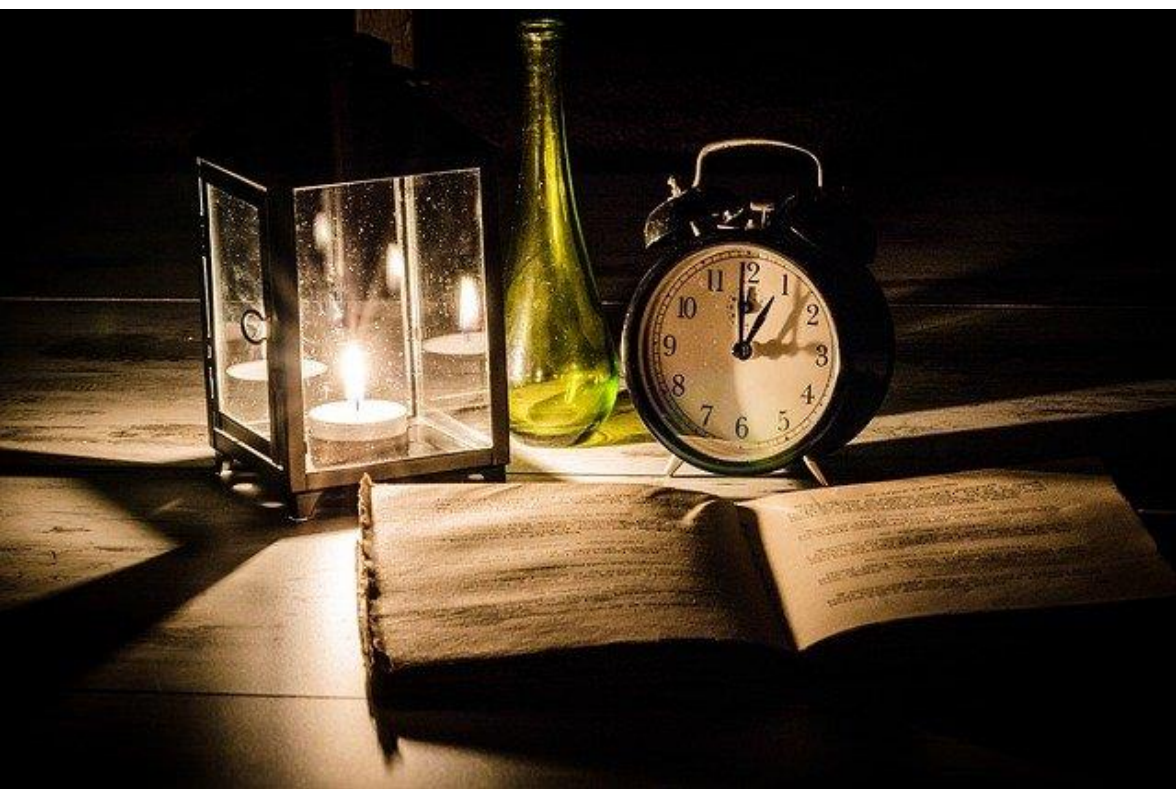

We are living in a world where 1.5 billion people lack access to electricity and lights that is approximately 20% of the world population, in some nations of African continents only 1 percent of the entire population has access to some form of electricity and lighting.

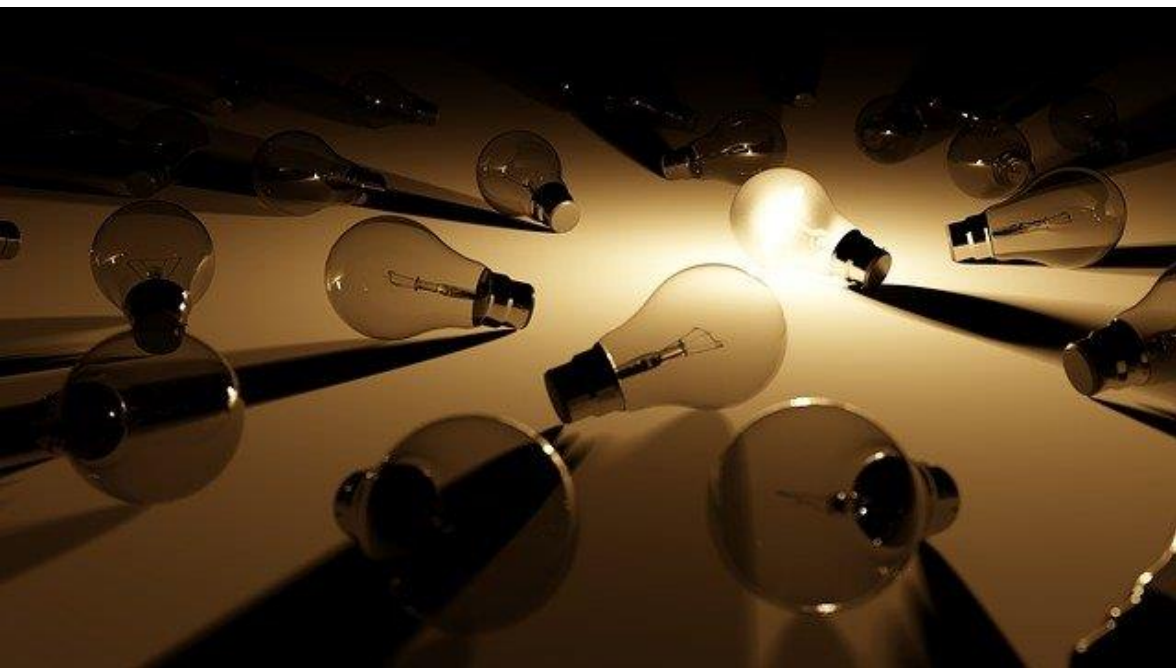

The Innovation of the Free Source of Energy will dynamically result in the end of light poverty on a global scale and all those poor countries that do not have access to light and electricity will soon have an infinite source of power supply for lighting up their entire nation.



All those continents that lack access to energy will soon have an infinite supply of electric power to light up their entire nations in the most reliable and efficient manner possible due to the innovation of Free Source of Energy.



3.5 Portable Medical Equipment Industry

We all know that portable instruments are the new trend in the 21st century and no one can survive easily without the support of portable equipment's, in the current era many nations suffer because they lack the important amenities of life like access to a proper hospital for medical support and emergency care.



According to who.int half of the world lacks access to crucial health facilities, and around 800 million people have to spend their 10 percent income for availing medical services, it is also stated that around 100 million people have been pushed into the status of extreme poverty due to costly health-care services.

Due to the lack of proper healthcare facilities, many nations have started to see new inventions like portable medical equipment to battle extreme poverty, and for providing the low-income residents a means of mobile medical services in the remote areas of their countries.



The global Portable Medical Devices market was valued at \$48.2 billion dollars in the year 2020 and is anticipated to reach the market size of \$80.3 billion dollars in the year 2027, according to globenewswire.com.

The innovation of Free Source of Energy will dynamically affect the Portable Medical Equipment industry and will help it grow much bigger in size due to ever-rising demand in the poorest nations on earth.

In the future, the Portable Medical Equipment industry will dynamically benefit from the innovation and technologies of Free Source of Energy, because most of the portable devices will run on a Free Electric Power Source, and that means this portable equipment will be utilized at a much higher scale thus many people will be treated with mobile health care facilities.



3.6 Urban Environment Planning

There are around 10,000 cities in the world and half of them did not exist just 40 years ago, according to nextcity.org. Urbanization is the new face of the transforming world we currently live in, every country is planning to upgrade its existing infrastructure towards better urbanization.



Around 54% of the world's population were living in an urbanized environment in the year 2015, and that accounts for 5.6 billion people, according to the ec.europa.eu.

The 68% (Percent) of the global population is anticipated to live in an urbanized environment by the year 2050, according to un.org. Urbanization is one of the major reason behind the success of many developed nations around the globe, advancement in urban infrastructure, directly and indirectly, affects the progress

of all sectors of an economy, and the general population living in an urbanized society are privileged by all means of modern necessities, and have access to all important and key amenities, which are essential for human development and their success and survival in the very competitive modern world we all live in.





3.7 City Infrastructures

In the near future, the Innovation of Free Source of Energy will dynamically affect the cities and their infrastructure, and all the products and services within each city will be directly and indirectly be affected, the majority of future cities will start transforming and will entirely depend on the Free modes of electricity, thus existing

cities will soon start upgrading their infrastructure to be more compliant with Free Source of Energy Technologies.



3.8 Carbon Free Cities

The nations around the world will soon realize the importance of a Free Source of Energy and that realization will result in a massive transformation, the streets will no

longer emit carbon dioxide the way they do now, as all the vehicles on the road will be fully run-on Free Electricity due to the modern innovation of Free Source of Energy.



3.9 Lighting infrastructure

The innovation of Free Source of Energy will dynamically affect the lighting industries and will transform them globally, thus In the future, the cities will start using those lighting technologies which does not

require an expensive power source, and all the existing and traditional lighting schemes and their technologies will soon be upgraded into units, which will consist of those components and technologies, that will have the capacity and capabilities to generate and supply an infinite amount of electric power, and these new lighting schemes will light up cities in the most efficiently reliable, and cost-effective, and in the way which has a zero utility expense.



Powerplants based on the Free Source of Energy technology will power all the city's infrastructures, including the city lighting schemes, and the new and advanced lighting schemes based on Free Electric Power will light up the roads and cities at zero expense.



Due to the modern applications of Free Source of Energy Technologies, the Cities will become brighter at night times at a zero electric utility expense, thus the city ambiance and nightlife will improve and

benefit everyone on a large scale.

For any nation around the globe, the street-lights are considered as an essential part of the city's development plans and are one of the major responsibility for just any municipality worldwide, the development of street lighting and its infrastructure is one of the major concerns for any economy's transportation sector, and for the road safety and traffic department.

A big and developed country like the United States of America requires very large billion-dollar funds annually to maintain, manage or put in place the street lights, The city of Los Angeles in the United States has around 209,000 lights and this particular city alone needs to spend \$42 million dollars annually for maintaining them, according to the ledlightingsupply.com.



4.0 Real Estate Properties

Free Source of Energy will dynamically affect the Real Estate Properties infrastructures globally, the real estate developers will soon start upgrading their existing units, and will prefer building those types of properties which will be having their infrastructure more compliant with Free Source of Energy Technologies. In the future, the property tenets and

occupants will no longer be needing to pay high electricity utility bills, because the buildings will run by power plants which will be based on Free Source of Energy Technology or else the property will have its own infinite power source generators installed and ready to use.



4.1 Power Generators

In the Future the Real Estate developers will prefer installing futuristic power generators that will be based on Free Source of Energy Technology, thus the

tenets living in the property will no longer be worrying about electricity as this utility will be freely available all the time.



4.2 Sensors

Free Source of Energy will power the entire Real Estate infrastructure along with the technologies, that are becoming more common, and are being installed more

often in the newer properties in the present modern world.



The technologies like sensors are used in a variety of ways in a property, especially in the hospitality industry, these sensors consume a lot of electricity to run, thus has a high operational expense, but in the future different types of sensor technologies, will highly benefit from the

modern innovation of Free Source of Energy, because these types of sensor devices will be fully operational all the time without any electricity shortages or electric utility expenses.





4.3 City and Building's Water Supply Infrastructure

Every building has its own Water Supply System, these systems are connected with the city's water lines, a water supply system costs thousands of dollars and also requires special maintenance on various occasions, a water supply system may also have a water pump which facilitates the process of supplying water to the building

units, likewise, a city has a set of a complex and vast network of water pipes which are interconnected and supplies water to all major locations within a city, the water line infrastructure requires a vast number of high powered water pumps to supply water in a large scale.



Most of the Water pumps consist of high-power motor technology, thus these

motorized water pumps have a very high electricity expense, which can easily become a burden for a growing economy.



4.4 Elevators and lifts

Every high-rise tower in the world has a special elevator as an essential part of its property, and without it, the tenants may not be able to enter their space and are not likely to prefer buying or renting a property

that lacks a lift or in which they have to take a staircase to reach their floor level.

The elevator market size was estimated at \$93.8 billion dollars for the year 2018 and is anticipated to be 135.5 billion dollars by the year 2026, according to gminsights.com.

Many small building developers and owners prefer not to install an elevator for their residents because of high electricity bills, as installing a lift can increase the rent and overall cost of the property.

The lift and Elevator industry will highly benefit from the innovation of Free Source of Energy, because in the future, things like an elevator, will run on Free Electricity, thus more people will consider installing an elevator on their properties.



4.5 Heating, Ventilation, and Air Conditioning (HVAC) and Ozone Layer Protection

Every modern building structure worldwide depends on some kind of Heating, Ventilation, and Air Conditioning System or Units, these systems are of high importance, and very essential for the everyday survival, of the building occupants.

The Global Heating, Ventilation, and Air Conditioning (HVAC) market size was \$240.8 billion dollars for the year 2019 and is anticipated to grow to \$367.5 billion dollars by the year 2030, according to [statista.com](https://www.statista.com).



The innovation of Free Source of Energy will dynamically affect the Heating, Ventilation, and Air Conditioning (HVAC) industry, as in the future these things will run by Free Sources of Energy, such as Free Electricity.

The modern Air Conditioning and the entire HVAC system will fully operate on Free Electricity, thus the residents and owners of real estate will no longer be needing to pay electricity utility charges.



The modern technology, and power generation of infinite Free Electricity, will be the result of power plants, and power generators, that will be build using the concepts of Free Source of Energy, thus

the residents of the modern cities will no longer be worried about accessing or lack of the crucial power resources, or for paying the high charges and taxes for the utilization of the Electricity power source, as it will become a free utility in the modern world.

By using the latest concept and technologies of Free Source of Energy in the modern Heating, Ventilation, and Air Conditioning Systems, the Ozone Layer will be better protected, because of the change in technology, there might be a big chance that your Air Conditioner will no longer be using old Refrigerant technology, to pass cool Air, but instead, it will operate on high powered fans to give a cool Air.

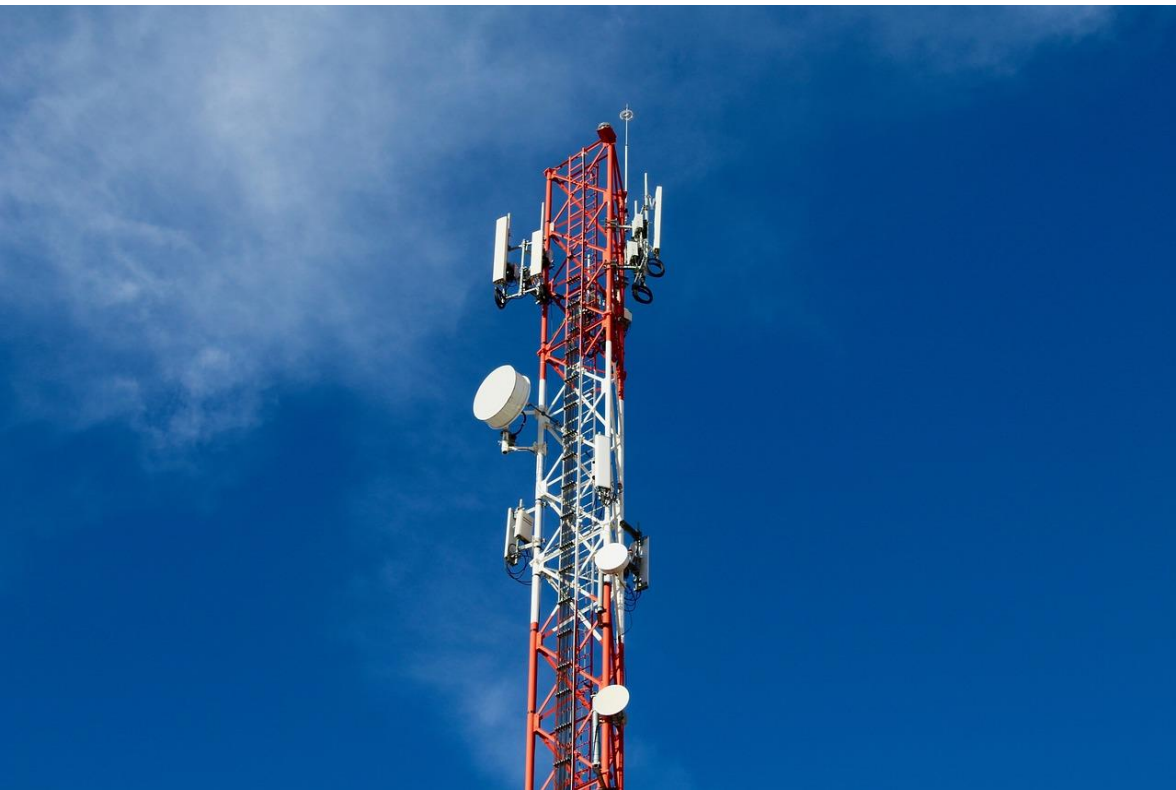

4.6 Telecom and Network Infrastructures

The worldwide telecom market size was estimated to be around \$1.74 billion dollars, according to [grandviewresearch.com](https://www.grandviewresearch.com), and is anticipated to grow into a market size of \$3450 billion dollars by the year 2022, according to [thebusinessresearchcompany.com](https://www.thebusinessresearchcompany.com).

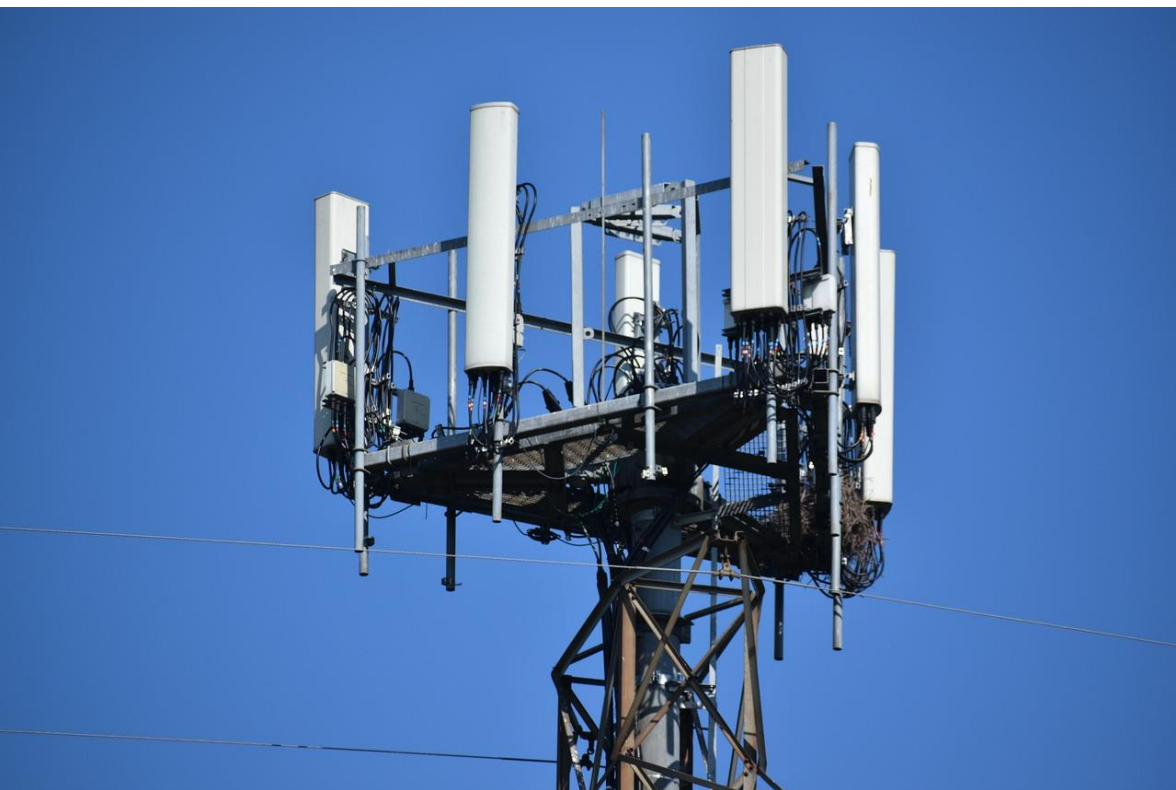

In near future the telecom industry will highly benefit from the innovation of Free Source of Energy because the operational cost of running a telecom business will decrease greatly, presently all the major companies in the telecom sector have to pay high operational expenses, not limited to the power charges, but still the utilization of electricity, for the entire network infrastructure, has always been one of the

main concerns, and primary expense, for any telecom company around the world.



4.7 Network Towers

The global Telecom Tower industry's market size was estimated to be around \$39.47 billion dollars for the year 2018 and is anticipated to grow to \$114.06 billion for the year 2026, according to [verifiedmarketresearch.com](https://www.verifiedmarketresearch.com).

In the future the network tower industry will transform and upgrade their existing tower products, to make them more compliant with the Free Source of Energy technologies, thus this industry will greatly benefit by utilizing the Free Sources of infinite Electricity.





4.8 Traffic Management infrastructure

The global traffic management market size was valued at \$30.6 billion dollars in the year 2019 and is anticipated to grow to \$57.9 billion dollars by the year 2024, according to [marketsandmarkets.com](https://www.marketsandmarkets.com).

Imagine an entire traffic management system, that fully runs and operates on, an infinite source of electricity, thus have no downtimes during operations, the innovation of Free Source of Energy

technology will dynamically affect the traffic management sector of just any economy.



4.9 Roads

The entire traffic management infrastructure, and all the existing road and traffic and systems, will be transformed to make them more compliant, with the modern innovation of Free Source of Energy Technologies, thus the power

shortages will no longer be the problem for the traffic management sector of any economy, due to the modern powerplants, and power generating technologies, made by the concepts of Free Source of Energy.





5.0 Radars and Sensors

Roadside Radars and Sensors technology will no longer face downtime due to the innovation of Free Source of Energy, and the governing parties will no longer be paying high operational costs, due to having access to an infinite source of electricity.



5.1 Traffic Lights

Imagine the entire Traffic Lights infrastructure that has no downtimes, and fully runs and operates on a Free and infinite Source of Electric power, thus has no operational or runtime expenses.

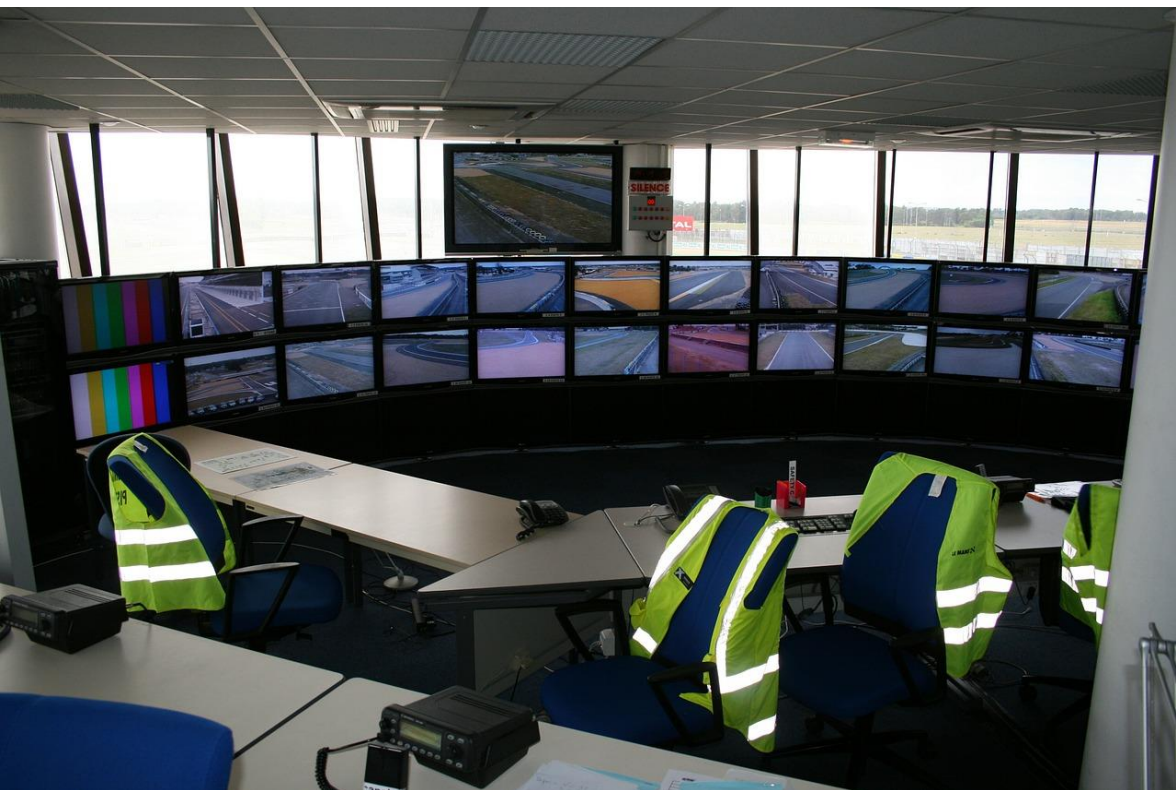

5.2 Remote Control Devices

A Traffic Management sector highly depends on smart control rooms, and remote devices to fully manage and control the entire traffic management infrastructure, these systems will no longer be having any power shortages, and will fully operate on Free Energy Technologies.



5.3 City Lighting and Decorations

City and street lighting are of utmost importance for any nation around the globe, it preserves the modern essence of success and prosperity for any country, the city's night life anywhere, entirely depends upon the lighting industry, people love going out at night-time to roam freely in the hustling, glowing and bright cities that are full of lights during the night.

The Traffic Management and municipalities, have to govern the ambiance of the entire city, on various special occasions, the city lighting and decoration are always transformed on special events like new year's eve, Christmas, or Eid day.



Imagine the entire lighting and decoration industry, being run on infinite sources of electric power, thus have no operational

expense, the innovation of Free Source of Energy will dynamically affect the lighting industry globally.

Free Source of Energy Technologies will dynamically affect the city and street light industry, as the cities will become brighter at night and those countries, that have no access to power sources, will no longer be dark at night-time.

Almost half of the world lacks access to energy, thus various developing nations remain darker at night, but due to the innovation of Free Source of Energy, these nations will avail and benefit from an infinite Source of Electricity, and will never run out of power.



5.4 Business and Real Estate

The global Real Estate market size was valued at \$6.8 trillion and is anticipated to grow into \$8.6 trillion dollars by the year 2026, according to alliedmarketresearch.com.



The Free Source of Energy will dynamically impact the Real Estate sector of any economy around the world, and in the near future the entire world will avail extremely cheap, affordable, and free sources of electric power, thus the real estate owners, will no longer be needing to pay for the high electric expenses, and will have access to an infinite amount of electricity for free.



5.5 Home infrastructure

Imagine a home in which every kind of product, no matter the type, will run on free electricity, whether it is your personal computer, mobile phone or an electric car, everything will benefit from a free source of electricity, without any restriction and charges of usage.

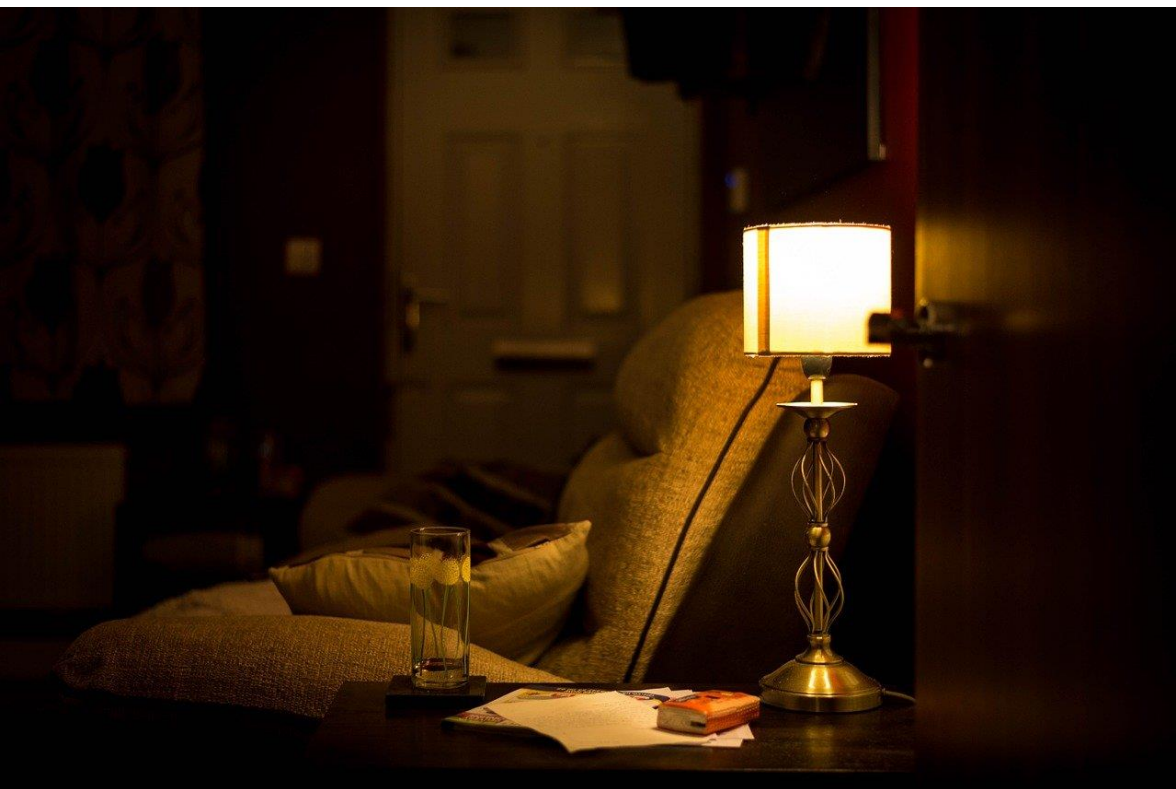

5.6 Lights at home

There will be no power shortages at night, thus no house will ever face load-shedding or low light at night-time.



5.7 Electronics devices at home

No matter the type of electronic, every device and electronic product will run freely on infinite electric power sources.



5.8 Home Essentials Equipment

Property owners will no longer be worried about running out of electric power, and all the essential equipment, at home, will freely run on free electric power sources, which will be available 24 hours a day, without any restrictions of usage, or power shortages.



5.9 Home Appliances

Crucial Home Appliances like the Culinary Tools, Kitchen, Fridges, or Freezers or Cooking Stoves, and Hygienic products like Washing Machines, Cloth Irons, all will run on free electric power, thus the homeowners will never be worried about paying for the high recurring bills for electric utility consumptions.



6.0 Smart Devices

Everyday Smart Devices like Mobile phones, Laptops, Radios, and Smart Television or Camera devices, everything that requires electric power to run, will benefit from the innovation of the Free Source of Energy Technologies, thus all the smart devices at home, will no longer run

out of charge, due to the power shortages, caused by the high electric usages, or recurring power expenses.



The technologies like the infinite power plants, or infinite power home generators, or built-in power components in electronics will revolutionize every industry of the world, due to the innovation of technologies that will be made by the concepts of Free Source of Energy.



6.1 Business Units Infrastructure

Commercial Real Estate is one of the most lucrative businesses in the world, it is the main pillar of the Real Estate market, every business in the world depends on commercial real estate, and it has always been one of the main expenses for any

business owner. Every successful business has its offices set up in a prime location, without an office, a business cannot execute its commercial activities.



The innovation of Free sources of Energy will dynamically affect the entire Real Estate industry and in the near future, the commercial setups will be transformed and made more compliant with the Free Energy Technologies.



6.2 Work and Office infrastructure

The Work environment and office cultures will be changed and transformed, as all the existing office equipment, will be upgraded and improved, they all will fully operate on advanced technologies, that does not rely, on finite sources of energy, instead, they will fully operate on an infinite power source, thus they will never run out of

charge, and all the essential and smart office equipment like computers, printers, telephone or projectors, will have their technologies transformed and upgraded, with the innovative concepts of Free Source of Energy Technology.





6.3 Transportation and Logistics Industry

The innovations of Free Sources of Energy will revolutionize the modern transportation and logistics industry, the transportation sector will highly benefit from the concepts and innovative technologies, that will have the Free Modes of infinite Energy, thus this sector will avail drastic reduction on operational costs.

The vision and theory will become a fact that in the future the modern vehicles, will no longer be running on fossil fuels, instead, every mode of transportation will fully operate and function on an infinite source of energies, no matter the type of transportation, every modern vehicle will have its primary or secondary power mode, that has infinite electric energy.





The Free Source of Energy will affect all the modes of Transportation, whether Air, Land, Sea, Deep Sea and Space, or Outer Space. Every transportation sector around the world will be transformed and made more compliant with the Innovations made from the Concepts and outcomes of Free Source of Energy Technologies.



6.4 Aviation and Aerospace Industry

The Global Aviation and Aerospace Industry will be benefited, transformed, and upgraded by Free Source of Energy Concepts and Technologies.



6.5 Air Transportation Industry and Aviation Fuel Market

The Global Airline Industry was valued at \$641 billion dollars in the year 2019 and is anticipated to grow to \$765.1 billion dollars by the year 2023, according to prnewswire.com.



The world's aviation fuel market was valued at \$179.2 billion dollars in the year 2018 and is anticipated to grow to \$238.5 billion dollars by the year 2026, according to the source at alliedmarketresearch.com.

The innovation of Free Source of Energy will dynamically affect the global Aviation industry, as in the future all the aviation industries will be transformed, upgraded and all the flying crafts in the future will fully run, operate and function on Free Source Energy Technologies, thus the aviation sector will save trillions of dollars and will greatly benefit by producing those products

and services, that fully operate and runs on an infinite power mode, and Free Sources of Energy.





6.6 Aerospace Industry

The global Aerospace industry market size was valued at \$342.4 billion dollars in the year 2019 and is anticipated to grow to \$378.5 billion dollars by the year 2023, according to prnewswire.com.



Imagine a spaceship or rocket that does not require any kind of liquid fuel to operate and instead they run on a powerful electrical air turbine thruster, this kind of aerospace technology will revolutionize the way we see the space industry and will benefit the entire aerospace sector of any economy around the world.



The innovation of Free Source of Energy will dynamically affect the entire Aerospace industry, and in the near future the Aerospace products like space shuttle or space rockets will operate on an infinite and free source of energy technologies, thus they will not require any kind of less efficient power tools to operate like the solar power panel or liquid fuels.



Modern concepts of Free Source of Energy Technologies will highly benefit the space industry, and one of the major advantages will be the drastic reduction in space accidents and special mission casualties, the world as the witnessing observer has seen many space incidents in which the lives of innocent astronauts have been compromised.



Everyone knows that manufacturing satellites and rockets costs billions of dollars and sometimes these costly endeavors get wasted due to unforeseen events, therefore the production of non-fuel rockets will enhance the overall safety of pilots, and will greatly reduce the explosion risks involved in launching the new rockets for various space missions like satellites launch, or space explorations.

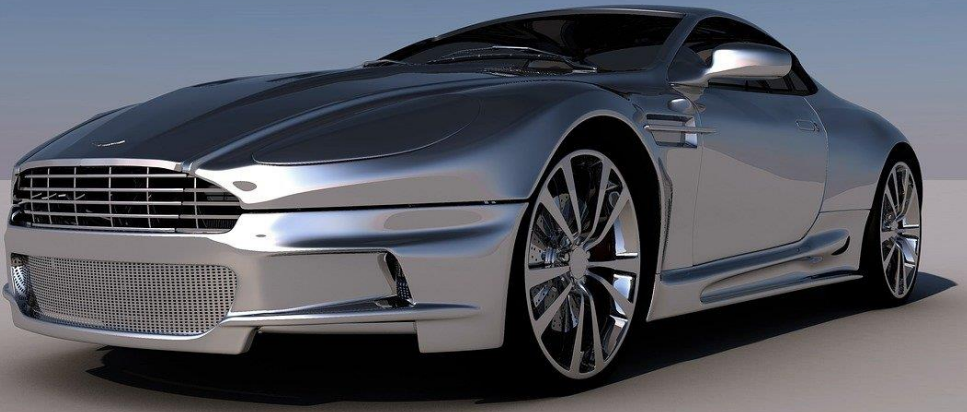

6.7 Automotive Industry and Land Transportation

The global automotive market size was estimated at \$20.321 billion dollars in the year 2020 and is anticipated to grow to \$25.719 billion dollars by the year 2025, according to prnewswire.com.

The combined global automotive industry's revenue is projected to grow from \$5315 billion dollars in 2017 to \$8931 billion dollars by the year 2030, According to statista.com.

Automotive is one of the major industries that is going to be the main adapters of Free Source of Energy Concepts, and the entire world's Automotive companies will soon be upgrading their existing Technologies and building newer ones that will be more compliant with Free Energy Technologies.





Imagine owning an electric car that does not require any kind of fossil fuel to run, instead, it has a special power generating technology that is capable of supplying an infinite amount of electric power for running and recharging the car batteries for a lifetime and forever.

The owners of this kind of vehicle will never require paying for car fuel refills, thus it will help the car owners save a lot of money that would otherwise be spent on buying fuel from a local petrol station.



Wonder traveling from one side of a country to another side without even paying a penny for the petrol refueling, The Free

Source of Energy Technologies will dynamically change the life of human beings, and owning a car and traveling will soon become one of the most inexpensive and cost-effective options for the residents of any economy around the globe.



The modes of Land Transportations like Cars, Buses, Bikes, Motorcycles, SUVs, Minibus, Trains, Trams, and Heavy Trucks

will become a very cheap and cost-effective method of transportation.

Local Transportation sectors around the globe will greatly benefit from the innovation of Free Source of Energy Techs because they will drastically reduce the operational costs, that are directly associated with fuel refills or international petrol prices.

in the future, the modern vehicles will consist of multiple power plans, and the existing power sources such as the fossil-fuels like petrol and gas will become the secondary backup plans for operating and running the vehicles, especially in the case of emergencies.





6.8 Marine Industry and Sea Transportation

The global Marine Vessels market size was valued at \$201.36 billion dollars in the year 2018 and is anticipated to grow to \$220.18 billion by the year 2026, according to [fortunebusinessinsights.com](https://www.fortunebusinessinsights.com).

The global Shipbuilding market size was valued at US \$114.3 billion dollars in the year 2018 and is anticipated to grow to

\$175 billion dollars by the year 2025, according to [statista.com](https://www.statista.com).



The Global Marine Port and Service market is anticipated to grow into \$87.8 billion dollars by the year 2023, according to [prnewswire.com](https://www.prnewswire.com).

The Marine industry is going to be one of the main industries that will greatly benefit from the innovation of Free Source of Energy Concepts and Technologies.

Imagine a Marine Vessel that does not require any kind of fuel to operate, instead, it runs on an infinite electric power, this sounds like a futuristic fantasy but soon it will be the new reality of the marine world.



All the Shipbuilding industries in the world will soon transform and upgrade their marine products and will make them more compliant and compatible with the Free Source of Energy Technologies.

In the near future, marine products like cargo ships and marine vessels will no longer require bunker fuel to run and operate, instead, they will have an infinite power generation technology built in them, thus they will not require any kind of bunker fuel to run and operate and will never run out of power.





6.9 Bunker Fuel Industry

The Global Bunker Fuel market was valued at \$137.215.5 billion dollars in the year 2017 and is anticipated to grow to \$273.050.4 billion dollars by the year 2025, according to alliedmarketresearch.com.



Due to the assumed reasons that In the near future all kinds of marine vessels like boats, ships and cruisers, etc., are going to run on Free Electric Energy, the world will soon start preserving the scarce oil and gas resources, and the marine industries around the globe will start utilizing the Free Energy Concepts for their marine products, The ship owners will no longer be needing

to pay for refueling their water vehicles, thus it will save them a lot of money that would be otherwise spent on procuring marine fuels.



The bunker fuel will soon become the second power option for all kinds of marine vessels and cargo ships, the ocean freight industries will save trillions of dollars that would otherwise be spent on bunker fuels.



7.0 Ocean Freight Industry.

The global Ocean Freight Forwarding market was valued at 115.930 billion dollars in 2019 and is anticipated to grow into 192.140 billion dollars by the year 2026, according to marketwatch.com.

The modes of sea transportation and ocean freight will soon become one of the most

inexpensive and cost-effective methods of transportation, due to the given facts that in the near future the marine products like ships, cruisers, and boats will no longer be needing bunker fuel to operate, instead, they all will be running on an infinite electric power source.



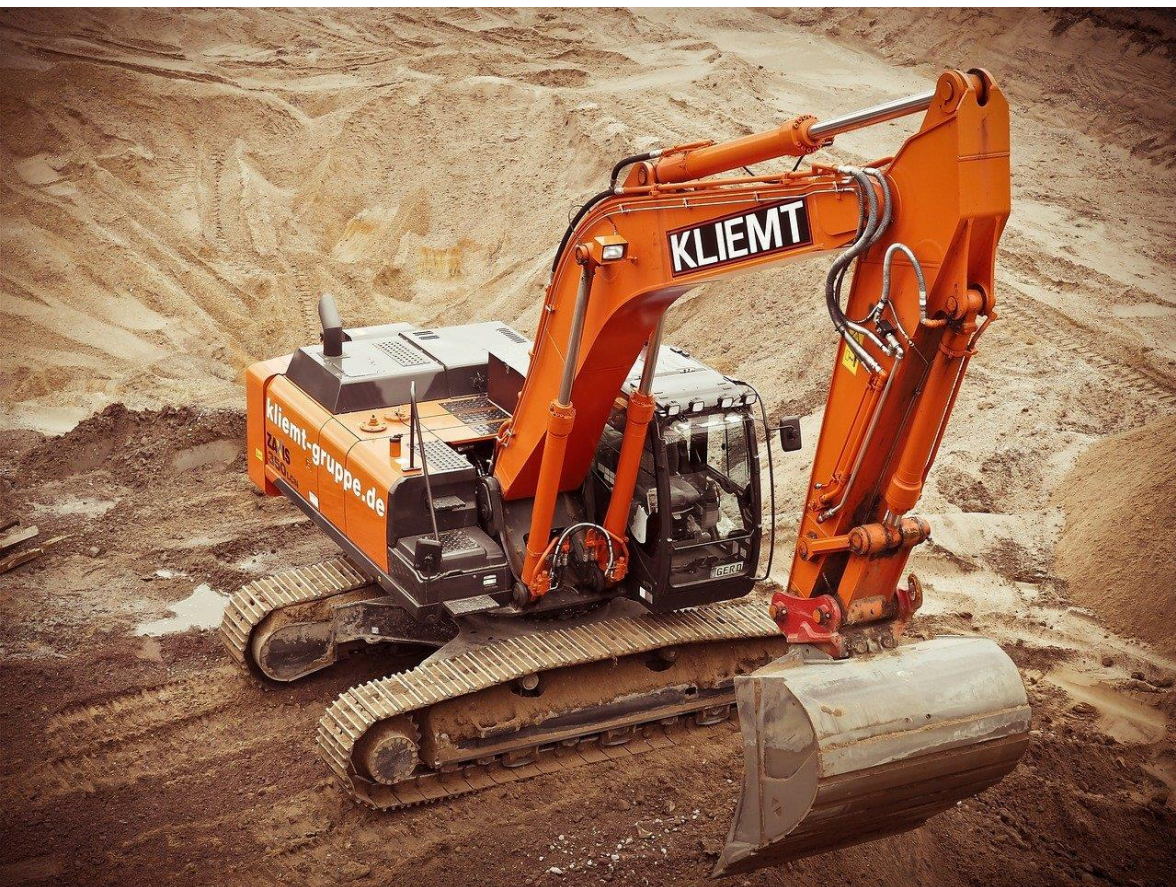

7.1 Heavy Equipment and Machinery

The global Heavy Construction Equipment Market was valued at \$171.66 billion in the year 2019 and is anticipated to grow to \$240.49 billion dollars by the year 2027, according to the source at alliedmarketresearch.com.

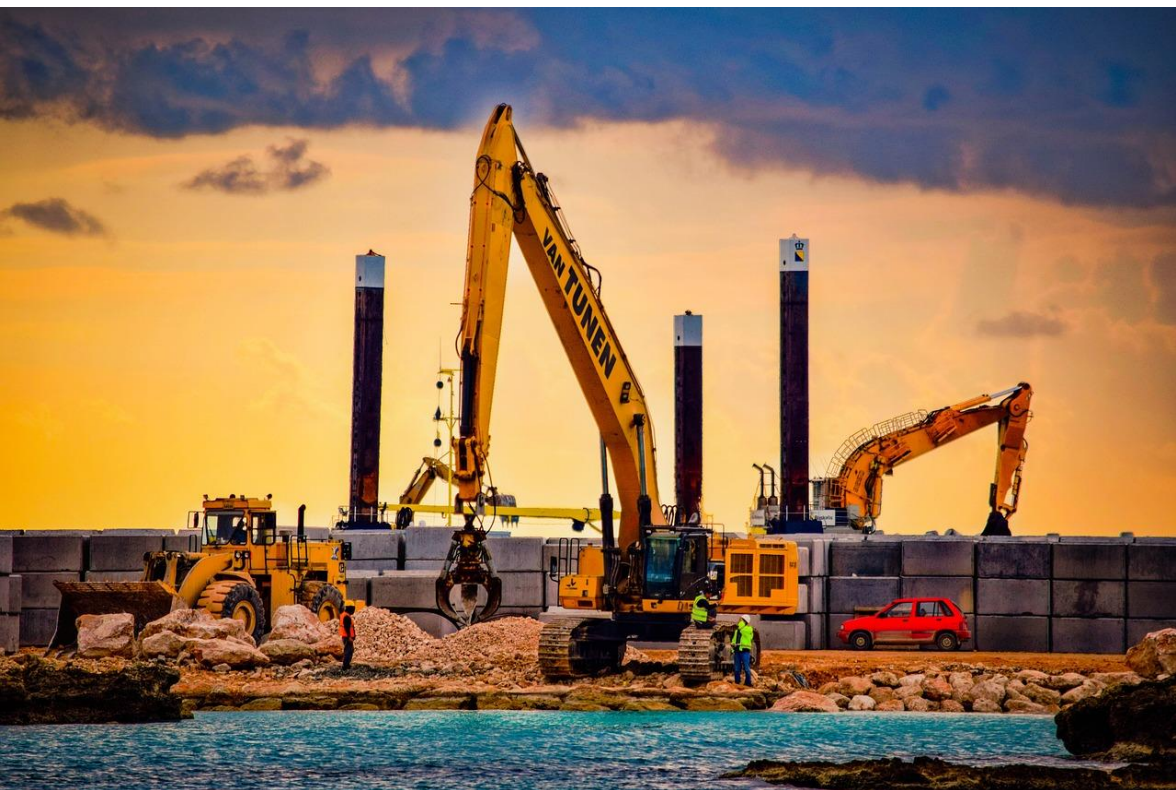

Heavy machinery is a result of massive progression in the intellectual and productivity of human engineering, these small to giant machines increase human efficiency many thousands of times if done with using them, mankind have built remarkable structures and astonishing architectures around the globe with the help of heavy machinery, some of them may have been heard and easily recognized like the Trucks, Bulldozers,



7.2 Hydraulic Cranes and Water Pumps.

The Heavy Equipment and Machinery industry will dynamically be transformed, upgraded, and improved and be made more compliant with the innovation of Free Source of Energy Concepts and Technology.



Imagine heavy equipment that does not require any diesel to operate, and instead runs and operates entirely on free energy, this soon will be the new reality for heavy machinery industries around the globe, and in the near future the products from these mega industries will no longer be needing fossil fuels for power, but instead, they will be fully electric with an infinite source of electric power, the diesel fuel will become the secondary power option that may soon be considered a less efficient power mode.



7.3 Smart Agriculture Industry and Farming

The global Smart Agriculture industry was valued at \$9.58 billion dollars in the year 2017 and is anticipated to grow to \$23.14 billion dollars by the year 2022, according to [statista.com](https://www.statista.com).

Agriculture is of utmost importance for any country of the world, it is one of the major tools to end extreme poverty and deaths that are caused by food shortages globally, around 65 percent of the poor working class sustained their living depending on agriculture, and this industry is projected to meet the need for about 9.7 billion people by the year of 2020, according to the worldbank.org.





The global added value for agriculture, forestry, and fishing was \$3.384 Trillion dollars by the year 2018 and was at \$3.503 Trillion dollars in the year 2019, according to the data.worldbank.org.

Imagine an agriculture field where all the major farming equipment does not require any kind of fossil fuels to power and operate, but instead, they all run on an infinite source of electricity, thus there is no operational cost for refueling of the crucial

machinery like Tractors, and Harvesting Machines, this kind of technology will greatly increase the overall production of any farm and will result in more cost-effective yielding output.



All the important agriculture industries will soon start upgrading their existing products into electric one, and the important machines like Tractor, Farm Truck, Mowers, Wagons and Sprayers will no longer be needing any kind of diesel or petrol to run, instead, they will fully operate on an infinite source of electricity.



Having field machines that do not require any kind of fuel to power will drastically reduce the operational costs, and they will greatly increase productivity at a large scale.



An egg factory requires massive set of special light bulbs to create artificial heating to hatch the eggs, but, all the major factories like modern egg farming will greatly benefit from an infinite source of energy and its technologies, due to drastic reduction in the electricity utility bills, as all the major factories will become capable to carry on their production with products that will not require any kind of operational costs, like the ones of consuming diesel

fuels and other fossil fuels for running farming machines.





7.4 Fishing Industry

The global fishing industry market was valued at \$240.99 billion dollars in the year 2017 and is anticipated to grow to \$438.59 billion dollars by the year 2026, according to prnewswire.com.

Imagine a fishing vessel that does not require any kind of bunker fuel to run, and instead, it fully runs on an infinite source of

energy, thus making fishing an inexpensive endeavor for fishermen around the globe.



In the near future, the shipping boats will no longer require any kind of expansive fuel to operate, and instead, they will be consisting of an electric engine that will run on an infinite electricity power generator, the bunker and fossil fuel will become the secondary power and backup option.



7.5 Courier and Global Delivery Market and Industry

The global courier service market size was estimated to be around \$341.32 billion dollars in the year 2019 and is anticipated to grow to \$533 billion dollars by the year 2026, according to marketwatch.com.



Imagine a delivery vehicle that does not require any kind of petrol or diesel to

operate, but instead fully runs on an infinite electric power supply, this soon will become the new reality for the global delivery markets around the globe.

Soon all the courier and delivery industries will benefit from having those transportation vehicles, that will have motorized engines with an infinite electric power generator based on Free Source of Energy Technologies.



The Transportation terminologies like Cost Per Mile (CPM) will become Time Per Mile (TPM), as the modern vehicles will no longer be needing to pay for refueling that adds an enormous amount of operational costs throughout the year, and badly affect the overall company's budget.

The modern artificial intelligence integrated and autonomous electric vehicles, will soon be equipped with their own power generators, that will make them never run out of charge, and petrol and diesel will become their secondary power and backup option.





7.6 Online Food Delivery Market and Industry

The global online food delivery market revenue was estimated to be around \$136.431 billion in the year 2020 and is anticipated to grow to \$182.327 billion dollars by the year 2024.

Imagine a restaurant that has a collection of autonomous delivery vehicles and

drones, that just delivers the ordered food to customers doors easily, and does not require any kind of fossil fuel to operate, but instead, it comprises electric and motorized engines with an infinite supply of electric power with an unlimited recharging capability.



No matter the type of delivery vehicle, whether a Car, Drone, Motorcycle or Bike, or Bicycle, every kind of future vehicle will soon be made compliant with the innovation of Free Source of Energy Concepts and Technologies.

The operational costs like cost per mile will no longer be a costly problem, and the delivery companies will soon become more competitive, and aligned towards the quality and speed of their delivery services.



7.7 Retail Industry and Market

The global retail sales were estimated to be valued at \$23.56 trillion U.S. dollars in the year 2018 and are anticipated to grow to

\$26.7 trillion by the year 2022, according to the source at statista.com.



Imagine a retail store that does not need to pay for its electricity consumption utility bills because it does not have any, this soon will become the new future of the retail industry worldwide.

All the retail and mall equipment will fully operate on an infinite power source no matter the type of equipment, the crucial electronic devices like Security Cams,

Laser Sensors, Digital Shopping Carts, and POS Machines will soon all operate without any power shortages.





7.8 Banking Service Industry and Financial Market

The global financial services market was estimated to be around \$22.5531 trillion dollars in the years 2019 and is anticipated to grow into \$26.5212 trillion dollars by the year 2023, according to [thebusinessresearchcompany.com](https://www.thebusinessresearchcompany.com).

The banking sector is one of the most in-demand for any economy in the world, and the wheel of an economy's financial industry fully relies upon modern banking, humans rely on banks to safeguard their financial assets and to carry on their every business activity.



A modern and digitalized banking industry needs to be up and running 24 hours a day, for providing a smooth and convenient

banking experience, to its growing customer base, but running every hour of the day requires a pool of smart interconnected systems and complex machines that depends on a vast number of networks, the network is a part of billions of machines that communicate to each other every second for exchanging crucial data information in order to accomplish the desired task on hand. These machines require a lot of power to run and operate, hence the power consumption charges are skyrocketing for the entire banking sector.



The global banking sector will greatly benefit from the Innovation of Free Source of Energy Technologies, and soon the machine-made operational costs will drastically decline because electricity will become one the most inexpensive utility around the globe.



The lack of power in the poor economies constantly results in a big productivity decline, due to the disturbance caused by the recurring load shedding, and businesses in the affecting regions around the globe cannot benefit from a modern banking infrastructure, because they lack

affordable and durable electric utility services, but soon the global economies will have banking services without any interruptions, and the equipment like ATMs, Computer Machines and Servers will no longer face downtimes due to the innovation and concepts of Free Source of Energy and infinite power-generating technologies.





7.9 Hospitality Industry

The global hospitality industry was estimated to be around \$466.57 billion dollars in the year 2014 and was grown into a \$600.49 billion dollars market in the year 2018, according to [statista.com](https://www.statista.com).

A hospitality industry involves all types of business organizations, that provides customers with all those crucial services that satisfy their essential needs like, modern healthcare services, resting spaces, leisure and entertainment services, refreshment services that provide food and beverages, and recreational pleasures such as beach, sports, gaming, cinema, spa and tour services, and vacation spots.



The hospitality companies survive by providing superior quality of services, that

do not come cheap, for instance, a hotel or hospital provides a 24-hour service, 7 days a week during their entire lifetime in business.



Every hospitality business in the world, highly depends on electric power for running their operations smoothly, whether it is energy-saving light sensors in a standard hotel or a 24-hour available emergency system in a hospital, the

electric power is consumed at a very large scale and for that, the organizations need to pay a handful of money for its utilization.



8.0 Education Industry

The global Education services industry market was estimated to be around \$3.1671 trillion dollars and is anticipated to grow into \$4.2555 trillion dollars by the year

2023, according to businesswire.com.



Every economy in the world depends on advancement in education, for creating a better and sustainable future for their youth, and the modern schooling is becoming more sophisticated on daily basis, the present and the next generation of school-kids will go through a more advanced, and vibrant learning experiences, they will learn from those technologies that most of our

baby boomers generation dreamed of, but the advance education is becoming an attainable choice for the higher societies, and the middle and lower classed group of people are being crushed by the costly educational plans.

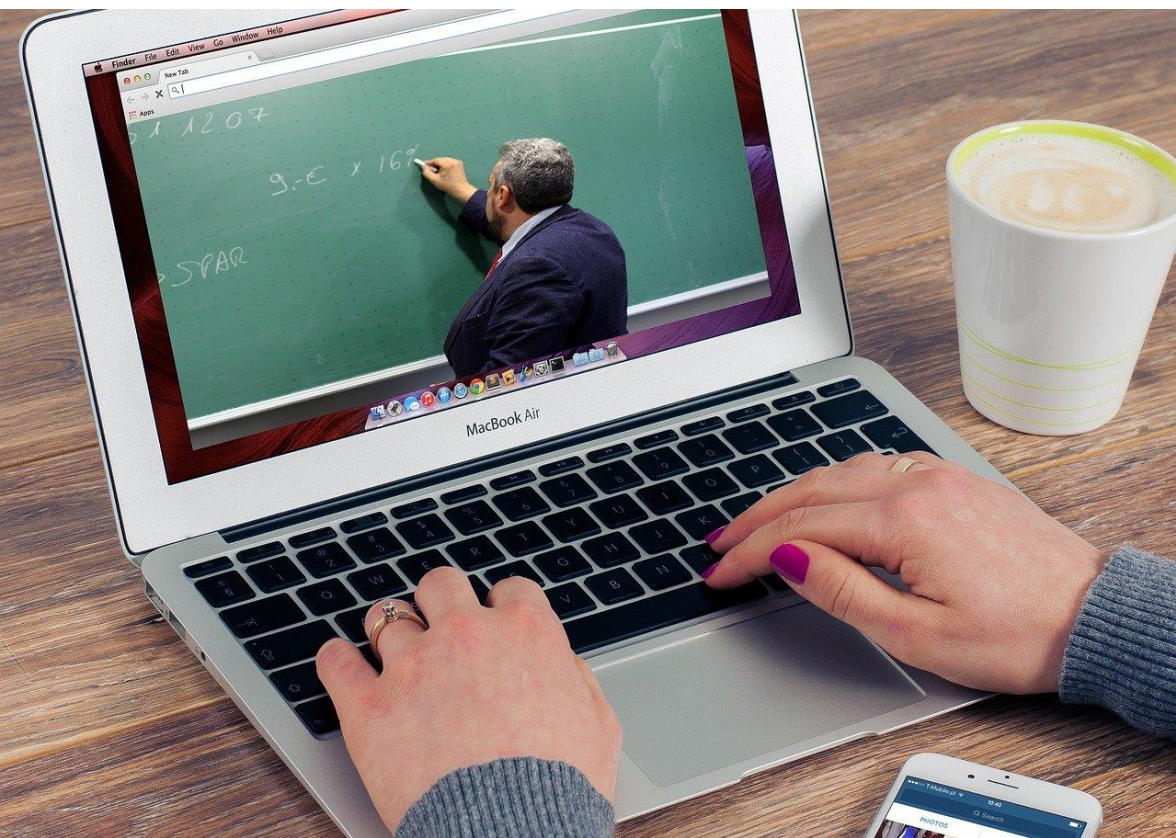

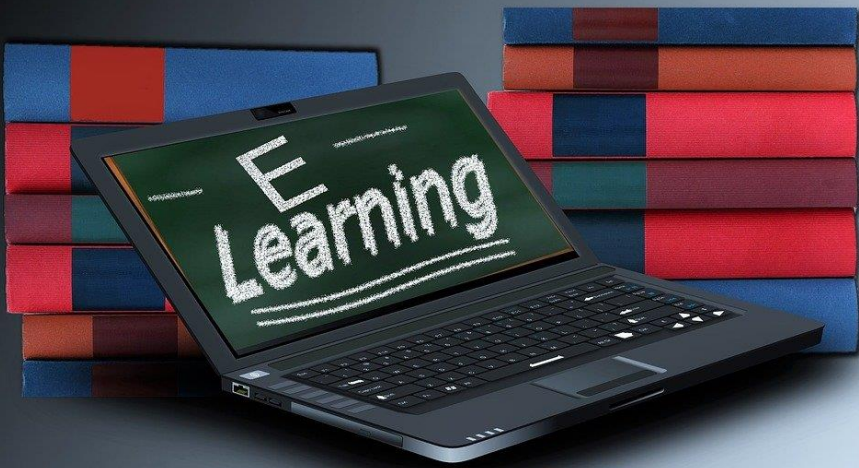

In the future, the schools will tend to use many types of advanced equipment, and modern educational technologies, that will provide a richer learning experience to their students, some of the tools that may be used are digital and electric boards, computer systems and, smart tablets, smart TV and advance projectors, and the printers and many more.

The increase in the school technology and equipment will require massive consumption of electric power, thus electric power consumption will become one of the

primary expenses for the educational facilities.



The Innovation of Free Source of Energy Concepts and Technology, will dynamically impact the modern education sector, and the schools and universities around the globe will benefit from infinite and more sustainable power sources to run their

facilities, electricity will become one of the most inexpensive utility, thus many governments will not even prefer charging an education institute against their energy consumption, hence the school and colleges will ultimately benefit by reduced operational costs, and that may aid a significant reduction in their fee plans, especially in the poor regions of the world.



PART 2

How Free Source of Energy Can Solve Global Warming and Save Oil Reserves.



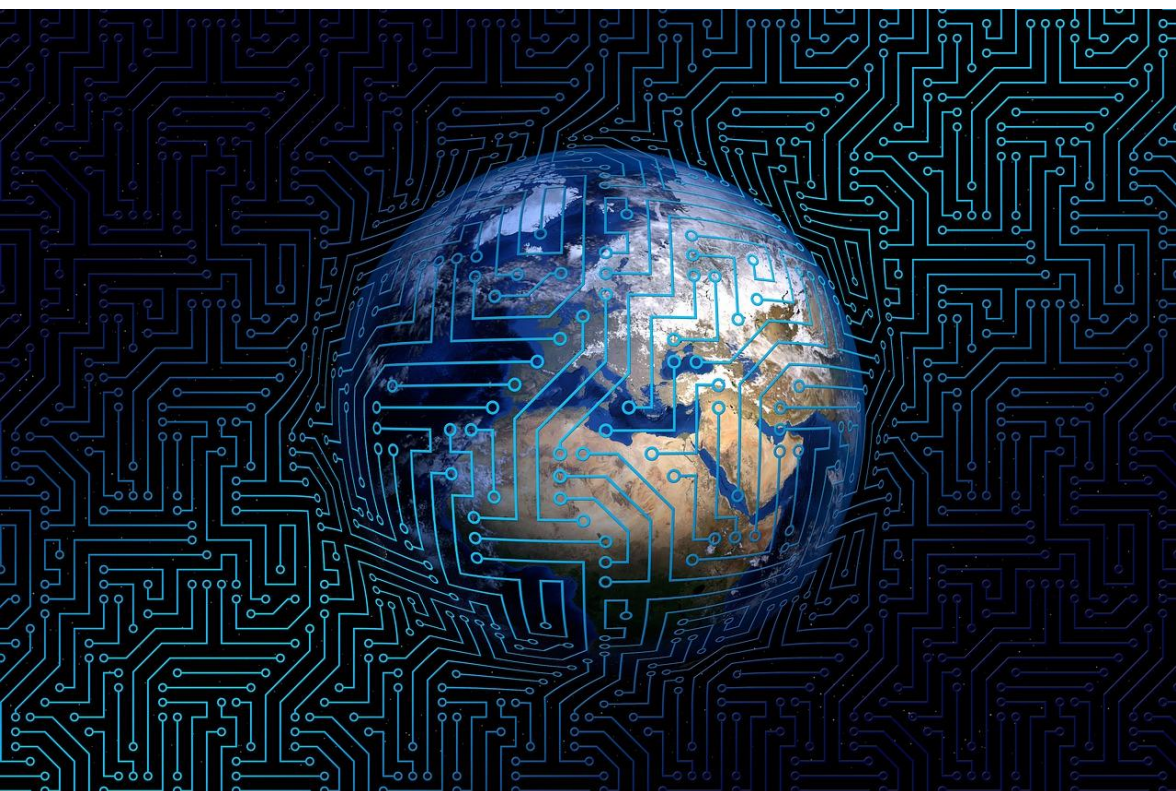

8.1 The Technology

Free Energy Concepts and their advancements will revolutionize the world and all the existing technologies will be upgraded, transformed, and be made more compliant with the innovation of Free Source of Energy, and its technologies.

Developing a mode of energy, that does not require any kind of natural resources like, water, air, fossil fuels or nuclear fuel will greatly benefit humanity, and it will prove to be a better and more stable source of electricity.

The Free Source of Energy Technology will be the one, that will not require any kind of costly methods for generating power, it will not require any kind of fuels that emits harmful gases and leaves a carbon footprint or else life-threatening radiations or traces of radio activity.





8.2 The Impact

All the nations which lack power and energy will be dynamically transformed, and be advanced to the modern age, the invention of free sources of energy technologies will have a great impact on the developing countries and it will aid and convert them into modern civilizations.

The most amazing impact of the Free Source of Energy Concept and Technologies will be on climate change or global warming and the natural oil reserves.

Inventing a highly cost-effective, cheap, yet better, and Free Source of Energy will be a challenge that will save the world from global warming, thus it will save the planet earth and all the living creatures that are walking the planet and reside in it.





8.3 Environment Friendliness

The Free Source of Energy Technology will be highly eco and environment friendly, it will be far superior to the existing and traditional ways of producing power, as it will not emit gases that results in a carbon footprint like from fossil fuels or life-threatening radiations like the ones from the nuclear power plant disasters.



8.4 Carbon Free Planet

The Free Source of Energy Technology will have no Carbon-Footprint, and the technology will not be dependent on the fuels that emit carbon dioxide or other harmful gases that can pollute or affect the environment and atmosphere negatively.

The Eco Friendly and Zero Carbon Footprint Product and Services will be using the Free Source of Energy Technologies that will be environment friendly because they will be free from all forms of pollutants.

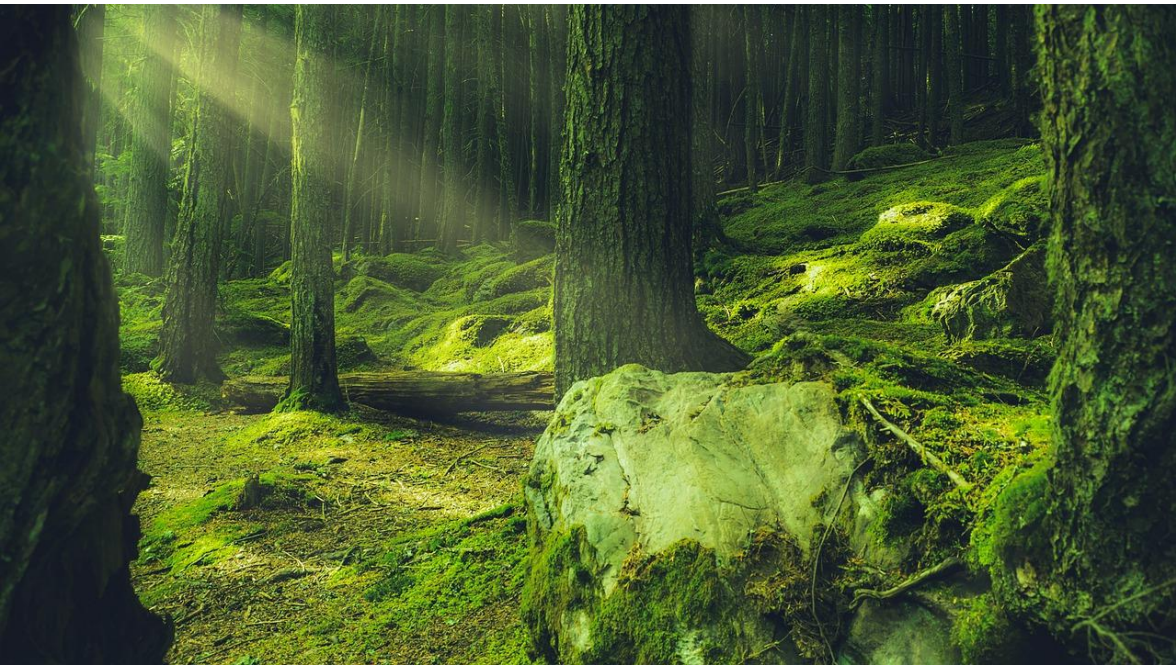

One of the major pollutants that are encouraging global warming is the use of fossil fuels by our transportations, the oil-related emissions are one of the largest and major contributors to global warming and climate change.



According to an article on ucsusa.org, the United States transportation sector which includes all kinds of vehicles, that uses oil as fuel generates nearly 30 percent of harmful emissions that contribute to the entire country's global warming.



The Free Source of Energy Technologies will upgrade, transform and replace all the existing power sources for our personal vehicles, and those that are under the transportation sectors globally, thus the automobile industries and transportation sectors worldwide, will no longer be responsible for contributing towards the global warming and climate change.

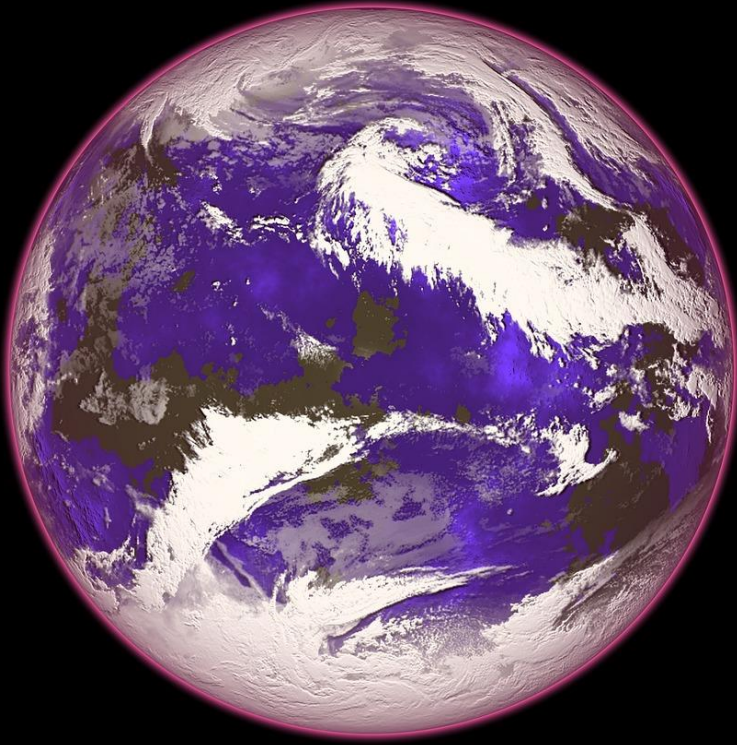

8.5 Ozone Layer Protection

The Earth Ozone layer is a crucial mechanism, that defends the earth against harmful radiation from the sun, especially the most harmful ones known as the Ultraviolet radiation, that is linked to aiding in life-threatening conditions in humans like, skin cancer, an eye condition called cataracts, and reduction in photosynthesis

in crops and plants, and harmful and negative impact on marine life, and that's why Ozone-Layer is vital.



8.6 Climate Friendly

The Free Source of Energy Technology will aid in the stabilization of climate change, thus normalizing the climate conditions of those regions around the globe that are being affected by climate change, and in the process of contributing towards global warming.

but to embrace the path towards innovating those sources of energies, that will become an absolute necessity, and a way of survival for all the living creatures on earth, including the planet itself, as Free Source of Energy Concepts and Technologies, will start seeming a more promising way, and the only hope or the only light at the end of the tunnel, for protecting the beloved planet earth, from horrible disasters of climate change and global warming, and those that will be caused by the end of all proven natural oil reserves.





8.7 Revolutionary Change

The reason why the Free Source of Energy Technology, will be extremely important and revolutionary, is because it will dynamically impact all the industries, businesses, and nations around the globe, and save the planet itself.



8.8 Technology Shift and Adaptability

The Free Source of Energy Concepts will cause a technological shift, and all the existing innovations will be affected by it, the present technologies will be transformed, upgraded, enhanced, and improved to keep up with the ultimate demand of Free Forms of Energies.

Owners of any kind of electronic device, equipment, vehicle or tool, will no longer be

needing to worry about the power source, as there will be plenty of free power alternatives available nearby.



Free Energy Features and compatibility will become the absolute necessity and essential demand for consumers, which will result in every business around the globe including Free Energy Modules and Technologies to their existing products and services.



8.9 Global Market Change

Free Source of Energy Concepts and Technologies will positively affect and benefit all the major markets around the globe, but some markets may be seeing both positive and negative trends, that may require some business changes, and discovery of different market opportunities, especially the Oil Markets which are already in danger of becoming scarce.



9.0 Impact on Oil Markets

The oil markets will see both negative and positive trends, but even without the innovation of Free Source of Energy Technologies, the dangers of oil scarcity are already on the way as all the proven natural oil reserves are depleting on a faster scale.



9.1 Effects on Oil Consumption

The Transportation Sector is the primary customer of Oil, as all the vehicles on earth, need fossil fuels to run, and operate, and every kind of automobile requires oil as fuel to make the vehicle run.

The Free Source of Energy Concepts and Technologies will dynamically affect the

automobile industries around the globe, and the Auto manufacturers will start making electric vehicles, that will have their own, Free Energy power source, hence the vehicles will not be needing fossil fuel, petrol, or diesel oil to operate, thus this change will drastically reduce the global oil sale volume because no one will be needing to buy oil or gas to run their vehicles or heavy machinery.





9.2 Alternative Energy

The existing modes of energy are not sufficient and reliable and do not come cheap, we can assume owning a car and then spending thousands of dollars annually on fuel.

Every kind of business needs an electricity connection, thus they all need to pay

thousands of dollars annually on utility bills, and the higher the output, the greater the expense.



Every home around the globe needs an electricity connection, and this resource is a primary expense for any household worldwide, no one can survive without electricity but still, there are many nations around the globe that lack power and lighting.

The Free Source of Energy Concepts and Technologies will become the change that will benefit every business, nation, and household around the globe, the electricity will become the most inexpensive and for granted utility for our future generations.





9.3 Economy and Energy Sector

The economies around the globe will see drastic savings, that otherwise be spend on energy schemes for a country, to build the power plants for the entire economy, the energy sector is deployed billions of dollars to spend on energy needs nationwide.



9.4 Banking Sector

The Banking Sector of economies around the globe will see a drastic increase in per capita saving, as the household will start saving money that otherwise is spent on power consumptions, such as for running a business, vehicle, equipment, home or tools, and the collective potential savings per household will be in thousands and more annually.



9.5 Uses and Diversity

The Free Source of Energy Technology will have diverse uses, and it will be used in all the essentials of everyday life, it will greatly decrease the consumption of harmful sources of energy, thus saving the planet and every in it.

PART 3

How can Free Source of Energy Save Planet from Worldwide Carbon and Air Pollution?





9.6 Introduction on Free Source of Energy Technology?

It is a Technology that is capable of generating an infinite amount of electric energy or electric power without the need for fuels like, fossil fuel, petrol, oil, or nuclear fuel or any which are harmful to the environment and planet earth, and all the living creatures that reside in it.



9.7 Why it is Important

The Free Source of Energy Technology is very important because of plenty of reasons such as, it is a source of an energy provider that is not harmful to our environment, planet, marine life, and all living beings.

Free Source of Energy Technology will help overcome climate change, and save the planet from global warming, by eliminating the top contributors that have the highest Carbon-Footprint that directly aid global warming, such as those that use fossil fuels to generate power or run our cars.





It will save the planet earth from the hazards of air pollution and its deadly contaminations caused by transportation vehicles and industrial machinery.

The Revolutionizing innovation of the Free Source of Energy will become the alternative energy solution for replacing expansive energy schemes like nuclear powerplant and wind turbines.



This technology will become a widely used form of power for all kinds of modern facilities, equipment, and tools, like electronics, smartphones, vehicles, home appliances, real estate, and heavy machinery.



As the depletion of all the natural resources like oil and gas is on the way, the Free Source of Energy Technology will become an alternative power source, for all those products and services that rely upon fossil fuels, and other natural and scarce resources.



9.8 Worldwide Carbon and Air Pollution Epidemic

Carbon and Air Pollution may seem like two different and broad topics, but they are closely related because the contributors and emitters of Carbon Footprint are also responsible for Air Pollution.

We can assume that in many nations, and especially in India, the major causes of street pollution are automotive, which are also the major contributor to climate change and global warming.





9.9 Understanding the Epidemics

Air Pollution is estimated to take the lives of 7 million people annually on a global scale, according to the who.int, and their data shows that 9 out of 10 people breathe air, which exceeds the limits of the WHO guidelines concerning the levels of Pollutants.



Air Pollution does not only affect the lives of the human being but also damages the environment and aid in global warming, the global carbon emissions estimated in 2019 had reached a record high number of 36 billion metric tons.

Carbon emission is responsible for trapping the heat in our atmosphere instead of letting it naturally released into space, this phenomenon is causing climate change, and because of this, the eco-system is

seeing adverse and life-threatening effects.



Marine life is being diminished at a rapid speed, and the scientist believes that the climate change is responsible for raising the temperature of our oceans and seas, one big evidence is the disappearance of coral reef globally.



10.0 Air Pollution Born Issues on Human Population

Global Pollution is responsible for causing various life-threatening side-effects on the human population, some of the major complications observed are premature deaths, and increased mortality caused by stroke, lung cancer, respiratory infections, chronic obstructive pulmonary disease, heart disease.



10.1 Air Pollution Effects on Lifestyle

Human Lifestyle is negatively affected by Air pollution, it not only shortens life expectancy rate but also diminishes human productivity by negatively affecting work life.

Many households in a country like India are badly affected due to being near to the

roads and automotive traffics, which tend to emit harmful smoke and gasses which enter nearby homes.

The diseases caused to humans by air pollution declines health, which causes an increase in healthcare expenses for the affected populations, that seek medical assistance to counter harmful side-effects of air pollution borne diseases

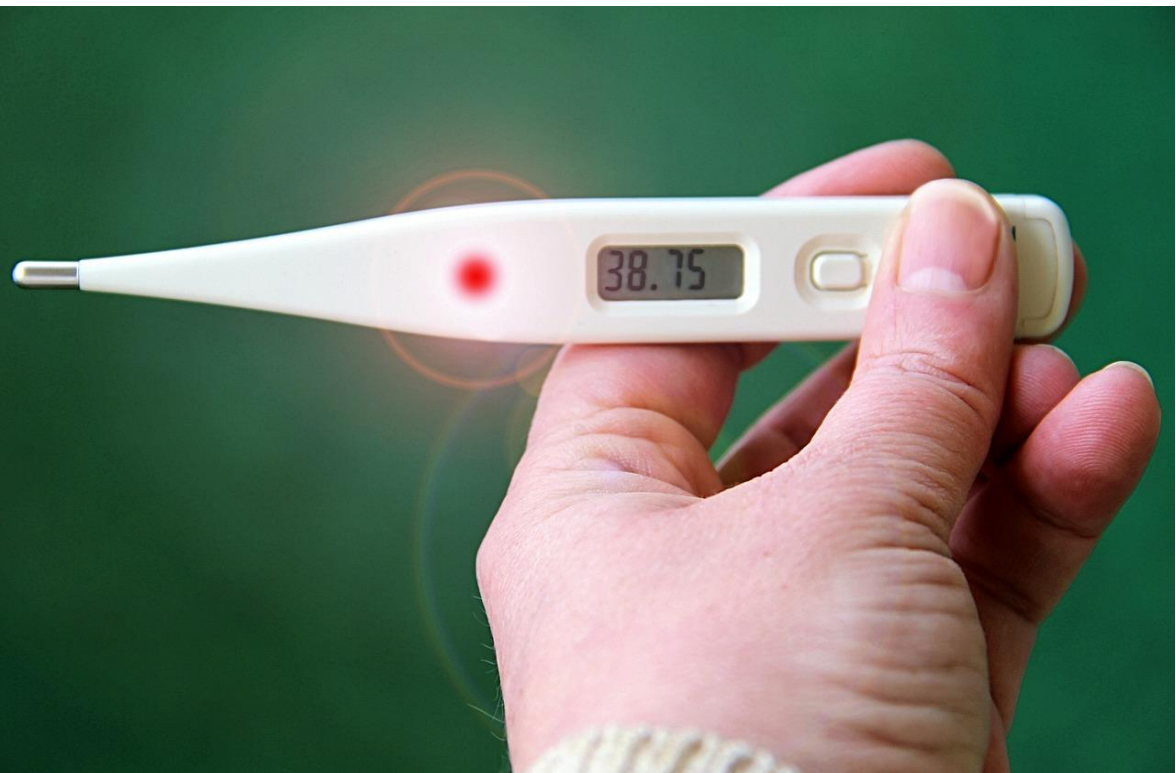



10.2 Air Pollution Caused Diseases

Chronic illnesses had been associated with air pollution, and some of them are Chronic Obstructive Pulmonary Disease, Stroke, Asthma, acute lower respiratory infections in children, ischemic heart disease, lung cancer, and premature deaths.



10.3 Deaths Caused by Pollution

According to the who.int air pollution causes 7 million deaths annually, and around 4.2 million deaths occur from exposure to ambient outdoor air pollution.



10.4 Death Rate Worldwide

According to ourworldindata.org, the year 1990 had approximately 115.67 rates of deaths per 100,000 individuals, out of which 10.88 were from outdoor air pollution, 43.68 from outdoor particulate pollution, and 61.11 from household pollution.

The Same source indicates that the year 2017 had approximately 65.85 rates of deaths per 100,000 individuals, out of which 6.23 were from outdoor air pollution, 38.15 from outdoor particulate pollution, and 21.47 from household pollution.





10.5 Global Warming Effects and Planet Earth's Health

Climate change is going to be one of the most dangerous disasters, that will have severe life-threatening effects on every living creature of planet earth, and the entire ecosystem is going to suffer directly or indirectly, the global warming is going to negatively affect all species on planet earth.

Some of the calamities of this epidemic are going to be, various populated islands drowning due to melting ice caps and mountain glaciers, which will result in a high rise of the sea levels.



Marine life disappearance and shortage of sea food, the devastating global loss, and death of ocean's coral reefs, that are

essential to much underwater life, the threatening depletion of oxygen levels, and rapidly increasing heat-trapping in earth's atmosphere instead of reflecting and releasing back into space, and the significant aid in human starvation caused by soil erosion due to the disturbing increase in climate temperature resulting in less rainfall in summer, that is needed for our agricultural productivity.



Climate Change is going to badly affect the weather conditions and will turn it into extreme in most regions, there will be more heatwaves, the rise in temperature will aid in frequent powerful storms and hurricanes. and prolonged droughts.



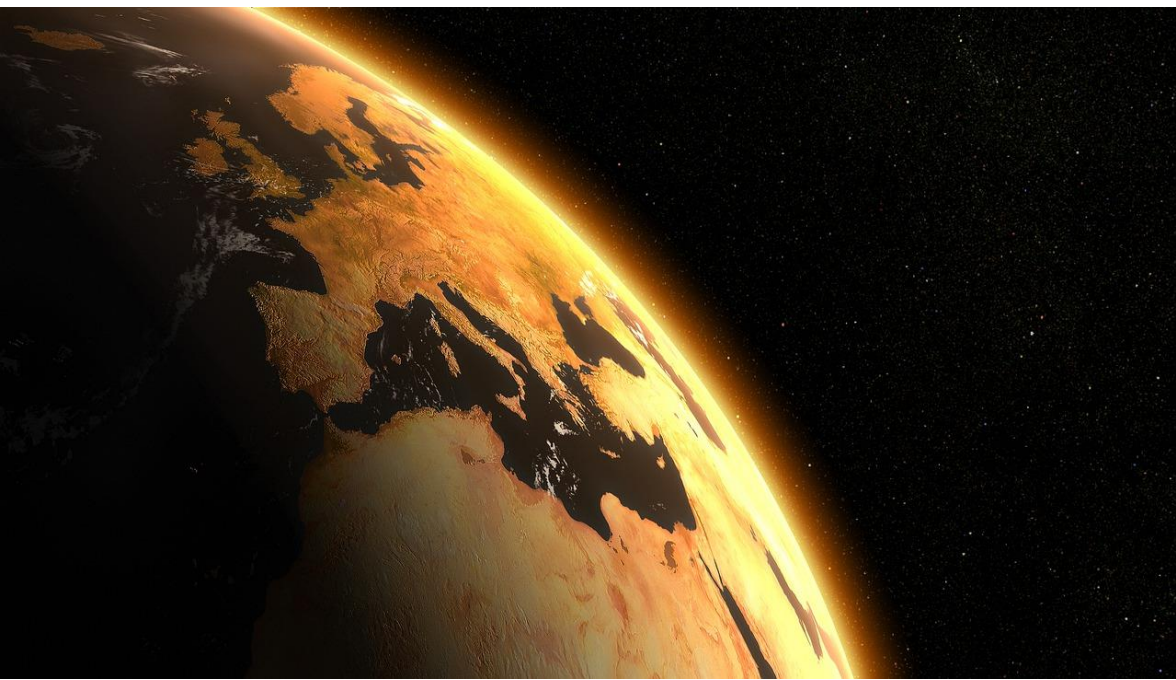

10.6 Climate Change and Air Pollution is a Global Issue

Every country of the world will be affected by climate change, and each nation around the world is directly and indirectly associated in aiding the issue, for example, the USA. Germany and Japan are the major manufacturers of Automotive and their products are distributed and sold globally, which makes them the contributors, the countries which have high

imports of automotive products, are also major contributors to climate change due to high carbon footprint, that is caused by utilization of fossil fuels by our transportation sector.



The transportation sectors globally, rely upon automotive, which are the major contributors of Air Pollution, there are many countries that do not manufacture

automotive but they are rich in oil reserves, thus their oil products are sold world-over, which makes them too, the contributors to causing the climate change, we can assume that every major country around the globe is affected by global warming, but they are also the primary interconnected contributors to the main cause.





10.7 Causes of Carbon Emissions and Air Pollution

The primary man-made causes for carbon and air pollution is the usage of fossil fuels by our transportation sector, we as humans utilize oil reserves to fuel our automotive, aircraft, and watercraft, other major cause is the massive industrial pollution, various factories and industries globally leaves

large carbon-footprint which aids in polluting our environments like air, land, oceans, rivers, and atmosphere, and harms eco-system that maintains the balance, which makes our planet earth healthy, and contribute to climate change at large scale.



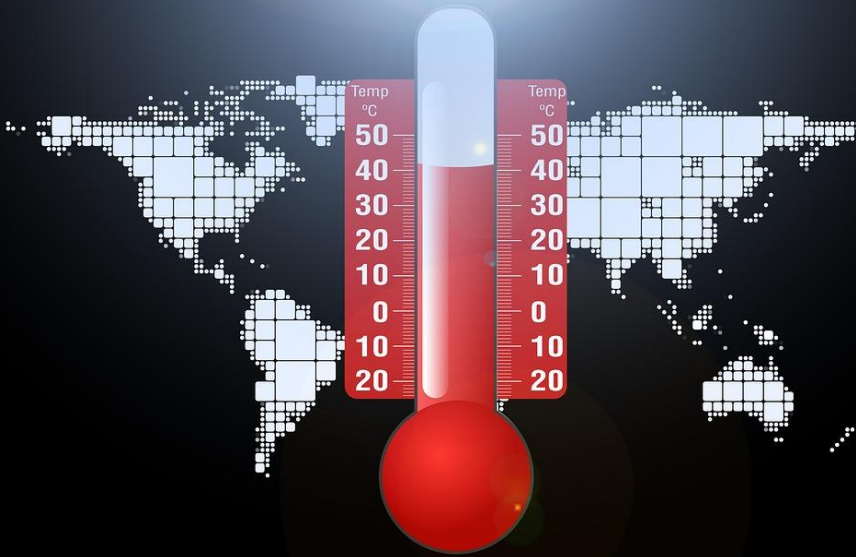

10.8 The Ultimate Solution to End Global Warming and Air Pollution

Free Source of Energy is the technology, which is going to revolutionize the world, this type of innovation is going to end global warming and air pollution from its root.



10.9 Why the Free Source of Energy Technology is an Ultimate Solution?

The Free Source of Energy Technology is the ultimate solution to end global warming and air pollution because utilizing this free energy source will not result in emissions of harmful greenhouse gases, and no fossil fuel or radioactive nuclear fuel is required to generate electricity from this technology, thus it is the safest way and the cleanest energy form.



11.0 Control on Carbon Emissions and Air Pollution

The Free Source of Energy Technology can be the best tool to control carbon and air pollution, due to the fact that it will transform every major industry that contributes to climate change.



11.1 Free Energy an Alternative Energy Source

The Free Source of Energy technology is an alternative energy source that does not require fossil fuels like, coal, oil, and gas to generate energy, countries do not need billions of dollars to build this technology, the pros of using this type of technology is that it is cost-effective and free way to generate energy.

Carbon Free and Reliable Energy Source
The Free Source of Energy Technology does not use fossil fuels to generate energy, thus it will not leave any kind of carbon footprint, it is a zero-carbon initiative, thus it can be the most reliable and clean source of energy.





11.2 Less Cost of Energy

The Free Source of Energy Technology will not have big operational expenses; thus, this form of technology can be freely used at large scale, the economies that will rely upon this form of energy solution, will not require their residents and citizens to pay big consumption charges as a monthly recurring utility bill, and most houses may need to pay small connection charges.



11.3 After-Effects of Ultimate Solution

The Free Source of Energy Technology will have numerous positive after-effects, this type of technology will save the planet earth from global warming and air pollution, and will leave a big positive mark on our history, it will revolutionize and transform all the existing technologies and businesses at a global scale.



11.4 Positive Effects on Worldwide Industries

The Free Source of Energy Concepts and Technologies will have a tremendously positive effect on the global industries, all the existing industrial technologies will be affected by this innovation, every type of business industry will start moving onto this free alternative energy, which will save industries from big operational and power expenses.



11.5 Rise of Carbon Free Industries

The Free Source of Energy Concepts and Technologies will start the rise of fully carbon-free industries, and all the major contributors to climate change will no longer remain the causing factor, this technology will be the new net-zero carbon initiative world-over.



11.6 Carbon Free Heavy Industries

The heavy industries will greatly benefit from Free Source of Energy Technologies, due to the fact that it will become a free power source for these industries, thus will save them from big operational expenses.



11.7 Carbon Free Automotive, Marine, and Aviation Industries

The Automotive, Marine, and Aviation industries are going to be greatly benefited and will be soon transformed completely, by using Free Source of Energy Concept and Technologies, all the major industries linked to the transportation sector will start manufacturing those products and

services, which will not use fossil fuels as a primary power source, but a backup option for emergencies.



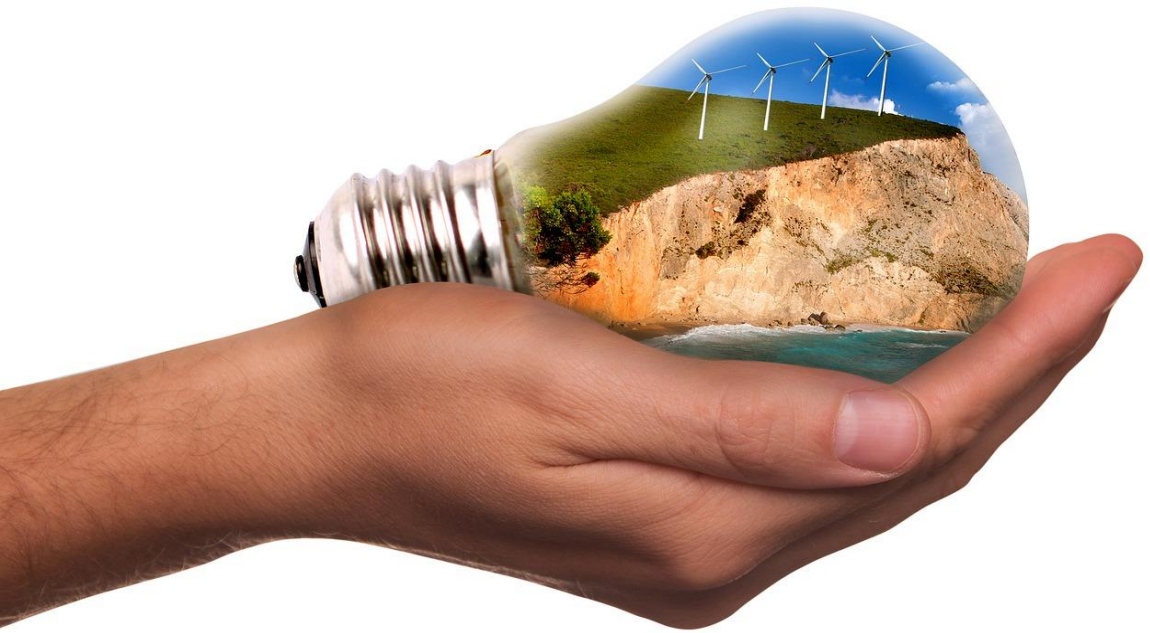

11.8 Carbon-Free Energy

The Free Source of Energy Technology is a completely carbon-free initiative, the power plants that will be build using Free Energy Concepts will not use any kind of fossil or nuclear fuels to generate energy, thus it will not be harmful to the environment.



11.9 Effects on Environment

The remarkable innovation of Free Source of Energy will transform our societies into cleaner, healthier and eco-friendly ones, all those horrible global warmings anticipated events due to carbon emissions and life-threatening diseases caused by air pollution will no longer exist. Humans, Animals, Marine life, Plants, and all existing living creatures on earth will start to have a much cleaner environment and may live a better, more productive, and longer life.



12.0 Effects on Cities

Populated cities will be transformed due to the revolutionizing innovation of Free Source of Energy, the states and cities globally will become a much cleaner and environment-friendly place to live in. The global tourism industry will start to boom again, the world will become a much better place to be in, all those developing nations

that lack energy will be greatly transformed and turned into a thriving powerhouse and scaling economies, and will contribute to the rest of the world as a new economic engine for a better world.





12.1 Effects on Population

The innovation of Free Source of Energy Concepts and Technologies will revolutionize, all major or most industries on a global scale, thus it will benefit mankind and provide them a better power source as alternative free energy, all the existing man-made inventions will start utilizing free energy modes, thus it will

greatly benefit the general population at a global scale, the free energy concepts will upscale all existing technologies and make them smarter for human utilizations.

People worldwide will start utilizing an infinite source of energy; thus, they will become more productive and efficient at their creative works. The positive outcomes of using Free Alternative Energy will save mankind from the disasters of global warming and Air Pollution, the rural areas will be transformed into modern futuristic urban cities with infinite power sources, and all existing places that are presently affected by air pollution will become cleaner and carbon-free globally.



12.2 Effects on Atmosphere

The elimination of harmful gases from the atmosphere will significantly improve the quality of air, and all the living creatures will breathe a much clean and toxic-free air with much higher levels of oxygen.



12.3 Better Wild-life

The wildlife will start to comeback, and greatly benefit from the innovation of the Free Source of Energy Technologies, all endangered living creatures will soon become a big part of our world, the animals will be populated again and their statistical count will be greatly increased.



12.4 Healthy Population

The clean atmosphere will give pleasant weather conditions globally, thus resulting in humans to adapt a healthier and more active lifestyle, and the air pollution will slowly fade away, thus air-borne diseases will be eliminated due to the adaptation of Free Energy.

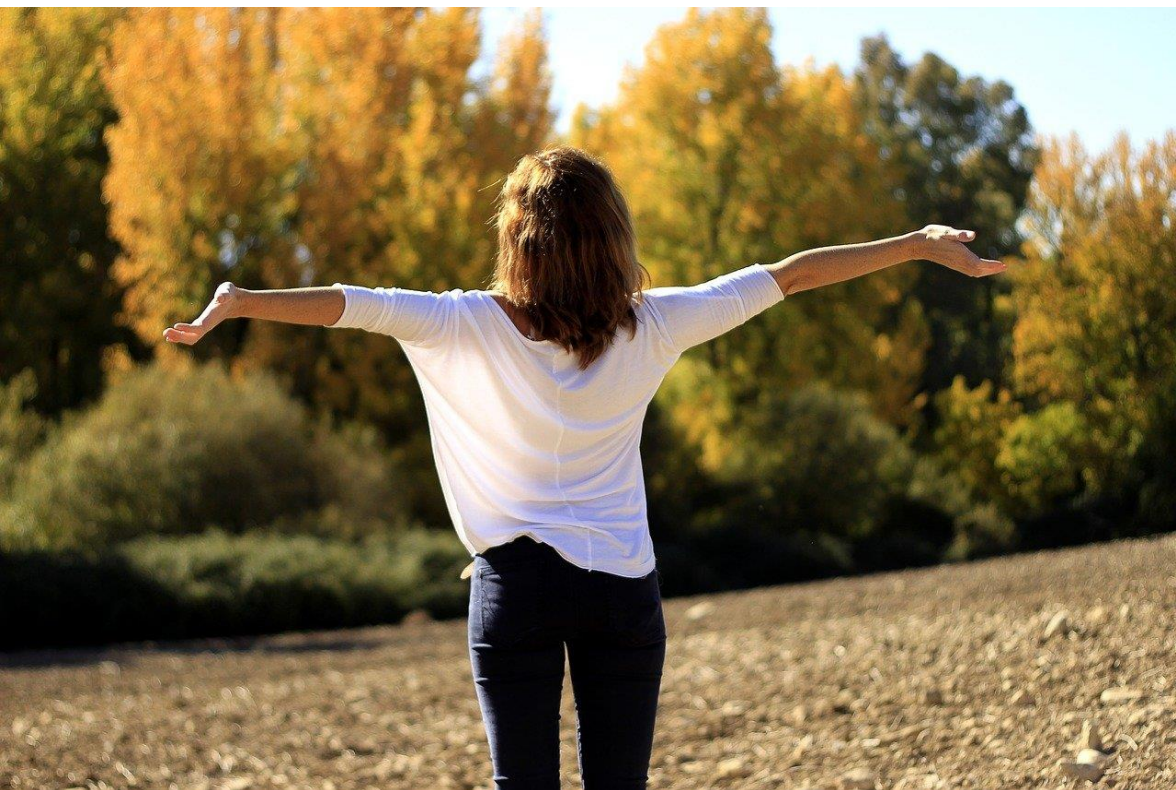

12.5 Clean Air

Less Air toxicity will promote better health, resulting in the human lifecycle becoming longer in the affected countries and nations around the globe. Air-borne diseases will be greatly decreased; thus, fewer people will become sick, and global death rates caused by air-born pollution and diseases will be reduced significantly.

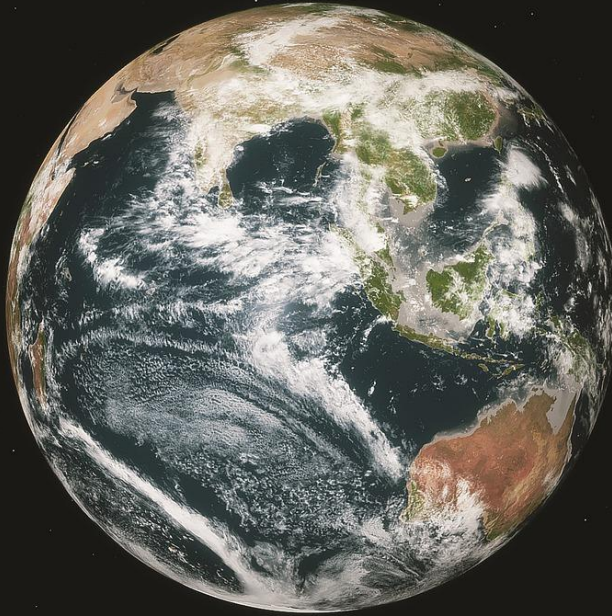

12.6 Effects on Climate

The innovation of Free Source of Energy Concepts and Technologies will act as an antidote to reverse the dangers of global warming and the risks will be significantly reduced, most of the anticipated climate change events will not happen at all, or happening them will be greatly slowed.

The Free energy tools will give humans a chance to overcome the deadly disasters of climate change and global warming as a whole. Prevention is better than the cure, and Free Source of Energy's innovation, concepts, and technologies will save the world from devastating events of climate change and global warming.





12.7 Effects on Planet

Ending global warming and reversing climate change will protect our earth from life-threatening and anticipated disastrous events, thus our planet will have a longer life and fewer natural disasters that be otherwise caused due to the rising climate change and global warming.



12. 8 Final Notes

We learned from the previous content, that building a Free Source of Energy is an outstanding and revolutionizing innovation, that will change the world for good, not only all living creatures but the entire planet will benefit from incredible Free Energy Concepts and Technologies.

All the existing industries will be transformed into a next superior stage of advancement, the electricity will become the most inexpensive and easily accessible utility for the world.



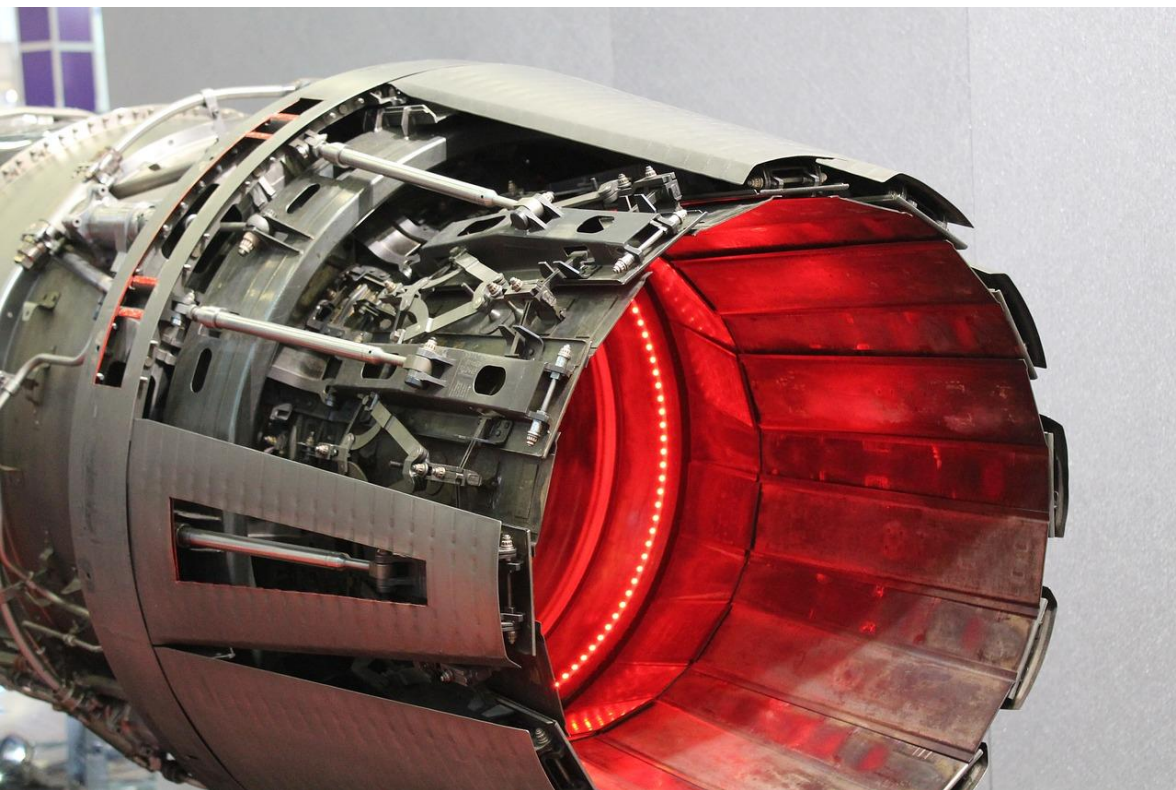

Every piece of technology will start utilizing Free Energy as its primary power source, and the existing energy modes will become the backup modes, the devastating environments we all used to live in will be transformed into more sustainable, reliable, and better for all living creatures, and many poor cities will become a powerful relic and mark of human advancement due to the rapid transition in future technologies, and

many of the places on earth that are affected by pollution will become pollutant-free and the air we breathe shall be more satisfying, fulfilling and cleaner than it ever was.



The dangers of Global warming and climate change will drastically slowdown and fade away, the marine life and the living

creatures on land will come back, the ecosystem will revive, thus the planet we all humans live on will thrive again more naturally, due to the absence of all those harmful carbon-emissions, and potent gasses that are being released into the atmosphere due to the human intervention, such as heavy industries, automobiles and all those machines that used fossil fuels to operate and run.





Street, cities, states, and nations around the world will greatly benefit from the innovation of Free Source of Energy Concepts and Technologies, the existing power plants may no longer be operational in the future, as the Free Energy Concepts will become the latest norm, the poor countries that lack power will soon have an infinite source of Free Energy Electricity to power their entire nation at very affordable costs, and in some, it will be a free utility.



Many of natural resources used for power generation will be kept saved, the global oil crises of the future will be smoothly handled, as all the products and services and industries that previously used fossil fuels for power, will start utilizing a more reliable and sustainable alternative, such as the Free Source of Energy Concepts and Technologies.



Scientists, economists, and revolutionary technologists will soon start debating on the importance of the Free Source of Energy Concepts and Technologies, and soon the entire world will start taking steps towards adaptation of Free Energy Concepts and Technologies.

RISE OF **FREE ENERGY ERA**



The world we live in will drastically change into the era of Free Energy for all, thus humans shall be one of the major beneficiaries of the revolutionary innovation of Free sources of Energy Technology.

PART 4

How Humans can Innovate Free Source of Energy Technology: Covering the Possible Strategy and Scenarios to Overcome the Ultimate Challenge.





12.9 Introduction - The Science and Art

The 21st century has seen unbelievable and remarkable progression, especially when it comes to technological aspects and newer innovations, from miniature smartphones and computer devices to autonomous automotive, we think we have seen all, but the human mind is an ever-evolving space, which is never going to stop inventing new things, and shall keep on surprising rest of the fellow humans.

We can say that science has taken its advanced form, due to heavy research in various scientific fields, but we humans have developed not only those technologies that make our work easier and living smarter but those as well which are contributing towards those unpleasant events such as the climate change and global warming.





Climate change and global warming is the result of extreme carbon emissions caused by the usage of fossil fuels, that are ultimately going to be diminished and become scarce in the next 50 years, so the dangers of such fossil fuel and their contribution towards global warming will no longer be a concern for the future generations, however, a new threat is emerging towards humanity with the

extinction of fossil fuels, and that is the energy crisis that is slowly going to progress and appear after next 50 years.

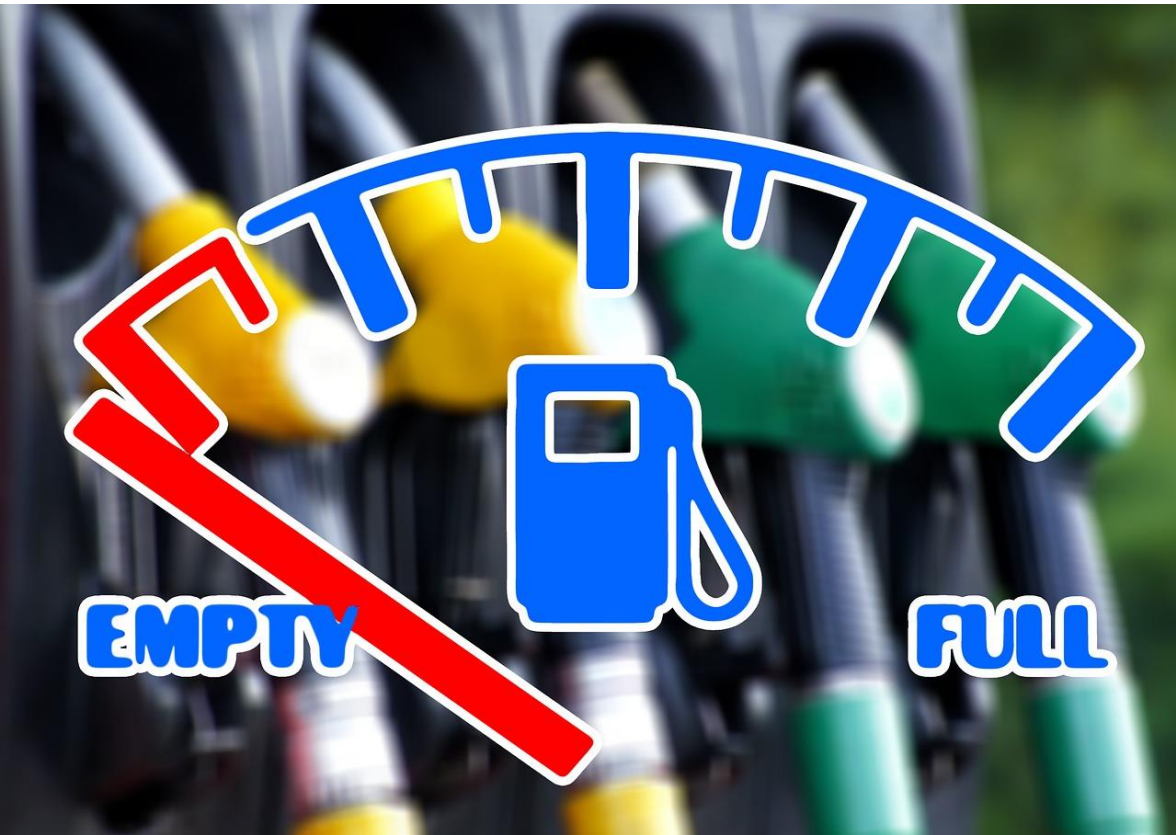

The Energy crisis will be one of the kinds which are going to affect all lives on planet earth, we have heard the word load shedding very often from the citizens of developing countries, but unfortunately,

there will be new terms that will soon be becoming familiar with the world, that are 'no lighting, or 'no electricity' or 'no power' and each of these two words is enough to demonstrate what the crises will seem like in the future.



Imagine a world where we have all the amazing smart technologies, but we cannot use them, due to insufficient energy supply, for example, no energy to recharge a

smartphone, no lighting at homes, no lighting in malls, shopping centers, hospitals, banks and anywhere else.



No fossil fuels to run a car, and no energy to recharge an electric car, no energy to run all kinds of portable transportations, like electric scooters, bikes, and electric bicycles, one-leg scooters, etc.

Before the devastating energy crisis takes its toll on humanity, we have to work together to come up with a revolutionary concept, no other than the innovation of Free Source of Energy Concepts and Technologies.





13.0 Belief in Science and Innovations

Humans are remarkable creatures, and their belief in science and technology has become very evident in the 21st century, if we can think of something then it can happen, our true nature lies in innovating things to satisfy our desired needs, thus we can overcome all those necessities that are essential for our own good and well-being.



13.1 The Power of Belief

We, humans, are challenging creatures, and if we see an obstacle, then we soon try to challenge ourselves to overcome any particular that is present in front of us. However, we not only have the capability to overcome challenges that are going to be faced early, but also those pending for the future.



Knowing that we all are going to be facing energy crisis and global warming, we can try to overcome the situations and events by planning ahead and foreseeing the threats, and the best possible solution to minimize the anticipated risks is to eliminate, all those contributors that are encouraging global warming, and coming up with those innovative solutions, that can save us from the energy crisis, thus we

need to start working towards an optimal path, that can lead us to a much more safe, and brighter future, and that is where the innovation of Free Source of Energy Concepts and Technology can prove to be the best possible solution, and a shot that we have against the foreseen dangers of energy crisis and global warming.





In the present times we have astonishing technologies and studies available to us, and thanks to the remarkable research and progression in the field of science, we can build a more sustainable future for our next generation, by allocating the right resources for developing those marvelous technologies and innovations that can save the future generation, from the devastating dangers of global warming and energy crisis.



Taking the energy crisis into perspective, we can presently assume that solar panels, wind turbines, and nuclear powerplants can answer to the future energy crisis but we cannot be assured that they alone would suffice to meet the rising demand, as global warming events untackled will cause bad weathers, storms, and droughts, hence solar panels, wind turbines, and nuclear powerplants will not be the reliable source.

We may assume that no one can guarantee the forces of global warming-induced bad storms to avoid and miss destructing of wind turbines, solar panels, or nuclear powerplants, which incase can become very dangerous and potent to humans after a radioactive disaster takes place, due to leakage of nuclear fuel after some bad destructive incident.



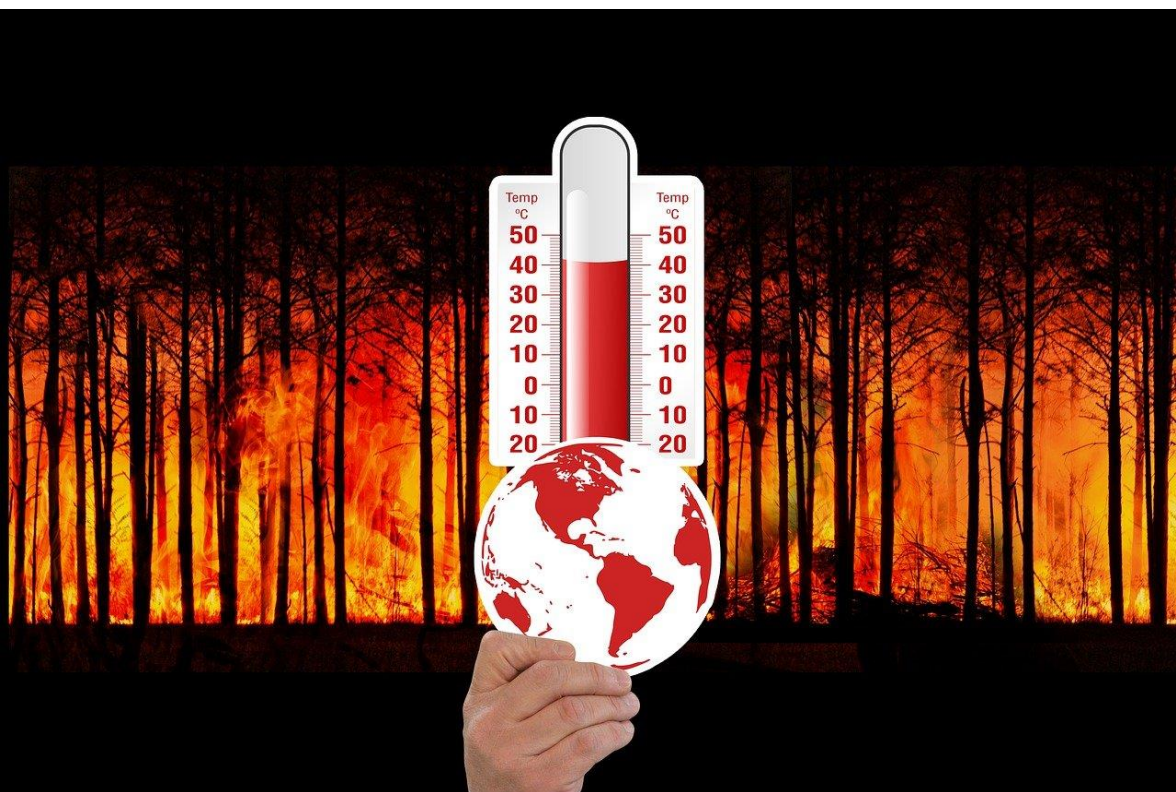

If we want to avoid the calamities of global warming or energy crisis then our best option available is to start working as soon, as possible, towards mitigating the destructive events before they take their toll on us.

As we all have heard that prevention is better than the cure, thus reversing climate change after global warming has begun, would be much more difficult than it is now, the same goes for the energy and oil crisis, as we can assume that the extinction or scarcity of oil and the energy epidemic will be way more difficult to cope, after these crises actually ever begin.



13.2 For Starters - The Two Important Parts of Creation

There are two essential parts, which are very crucial for the innovation of Free Source of Energy Technology and realization of its Concepts,

The First Essential Part covers the creation of an online platform dedicated to Free Energy Concepts and Technologies, where people from all around the world will be able to participate without any kind of restrictions, discriminations and biases, the intention of building such a platform is to empower all nations, and intellect minds or any person on the planet, who would like to contribute their innovations and invention and intellectual properties to achieve the common goal of turning Free Source of Energy Technology and Concepts into a reality, with being able to get rewarded for their contributions in terms of legally binding and contractual agreements of various natures, between the utilizers of such contributions, and the contributors,

and those that will be seeking royalty against the usage of their resources, intellectual properties, and knowledge sharing.

The Second Essential Part covers the crucial and vital mechanisms, components, mechanical and software technologies, and original ideas, and theories for implementing the Free Source of Energy Technology and Concepts, the second part is a core for turning the theoretical works into a reality, it demonstrates the forces that will enable the mechanical system to become infinite energy and unlimited electricity engine.

Both The First Essential Part and the Second Part greatly depends on each other, for example, the first part covers the implementation of a Free Energy Community Platform, where innovators globally can contribute their knowledge and support each other, and the Second Essential Part covers the essentials, and the basics, that will motivate and inspire the

community to take action, and make the Free Energy Projects into reality and convince all participants that it is a shot that is worth a try.

The Second Essential part covers the engineering ideas and mechanical concepts, that will become the backbone of the Free Energy projects and are the major frameworks, that will help global participants to understand and realize the common goals, and the fundamentals of implementing Free Energy Technology into a workable product, as an ultimate solution in a form of machinery.

The First and Second Part is not a solution that is going to remain vital for eternity, as, after the implementation of the Free Energy Community Platform, many innovators around the world will come up with ideas and researches of even a much better and bigger magnitude, this book is basically the first step by the author to inspire, and bring the world together to realize the dream of

making the Free Source of Energy Concepts and Technologies into a reality for creating a better world for our future generations.

In the near future this book and all its concepts may become obsolete, with the advancement in the Free Energy Concepts and Technologies, as the research on this particular subject will evolve to the next levels of improvements at a global scale, it is not as different as imagining a portable computer when in the past, a room-size CPU was a thing.





13.3 First Essential Part: Free Source of Energy Platform

In this First Essential part, we will discuss the frameworks of a Free Energy Community Platform, we will talk about the core ideology, and the complete picture of what the platform will be built for, and why it is required as an essential part for developing and turning Free Source of

Energy into a reality. We will also discuss and highlight important platform features and capabilities that must be incorporated within the online and offline platforms and shall cover all major concerns regarding the same platform, by unveiling the original ideas and proposing the concept within this book.



I D E A S



13.4 Awareness and Publicity

Building a Free Source of Energy Platform may not require extreme resources, yet the goal is to support and get support from all nations on planet earth, as it is a crucial requirement to mitigate future issues like the Energy Crisis, Global Warming, Oil

Crisis, Saving Planet and revolutionizing all major industries on the planet, for the better world and a brighter and healthier future, thus it is also required to bring the worlds technology leaders together to turn the project into a reality, and enrollment from major industry leader will greatly aid the process, thus turning a vision of this scale into a reality would become easier than expected.





Before we can actually build such platforms, we need massive publicity to make the world leaders aware of the main cause, and for that reason, major technology leaders and corporate support are needed, just assume a major billion-dollar brand supporting this cause, would make sense to many, for exemplary purposes we can say that a company like the General Motors(GM) who are pioneers in developing renewable energy, and a company like Tesla which are leaders in the world of electrical Automotive working together, with major software companies, like Oracle and Microsoft in order to

achieve building a Free Source of Energy Technology and associated platforms, thus it will make the mission more easily achievable.



We can say that there are countless industry leaders, and every XYZ company may have something tremendous to support the cause, there can be infinite examples, like Google and Apple building state of the art mobile application for the measurement of Free Energy Consumption, or a Rolls-Royce working on a new aircraft jet engine that would not

require fossil fuels, thus they would love supporting the cause. and SpaceX and NASA working on building the next generation of spacecraft and rockets, that entirely run and operates on Free Energy.





13.5 Mission Vision and Objective

The primary mission and objective of creating an online community platform, that is dedicated to Free Energy Projects, is to empower the innovators around the globe to develop and build the Free Source of Energy Concept and Technology Solutions, that will revolutionize the world economies and industries, and save the planet from the

devastating events of global warming, energy crisis, oxygen depletion, oil crisis, air pollution, and other unforeseen events related to the mentioned anticipated future crisis.





13.6 Unified Ideology

The fascinating thing about creating a dedicated Community of Free Energy Developers is that they all will have the same goal of revolutionizing the world with Free Energy Concepts and Technologies, innovators around the world will share their knowledge, and research works with the

community, and will support and help each other to bring the best of them, for achieving the goal of developing the state of the art technology, that will change the world, and will solve the world's top crisis which otherwise left untreated will bring chaos and devastating events, such as the global warming, oil crisis, energy crisis, air pollution, oxygen depletion, and any other related to the mentioned.





13.7 Global Invitations

All the nations around the world will be given the opportunity to join the Free Energy Struggle, thus every country on the planet will be invited to become the participants for innovating and turning the objective of Free Source of Energy Technology and Concepts into a Reality. No nation around the globe will be restricted from participation, and anyone residing anywhere in the world will be able to join absolutely free of cost.

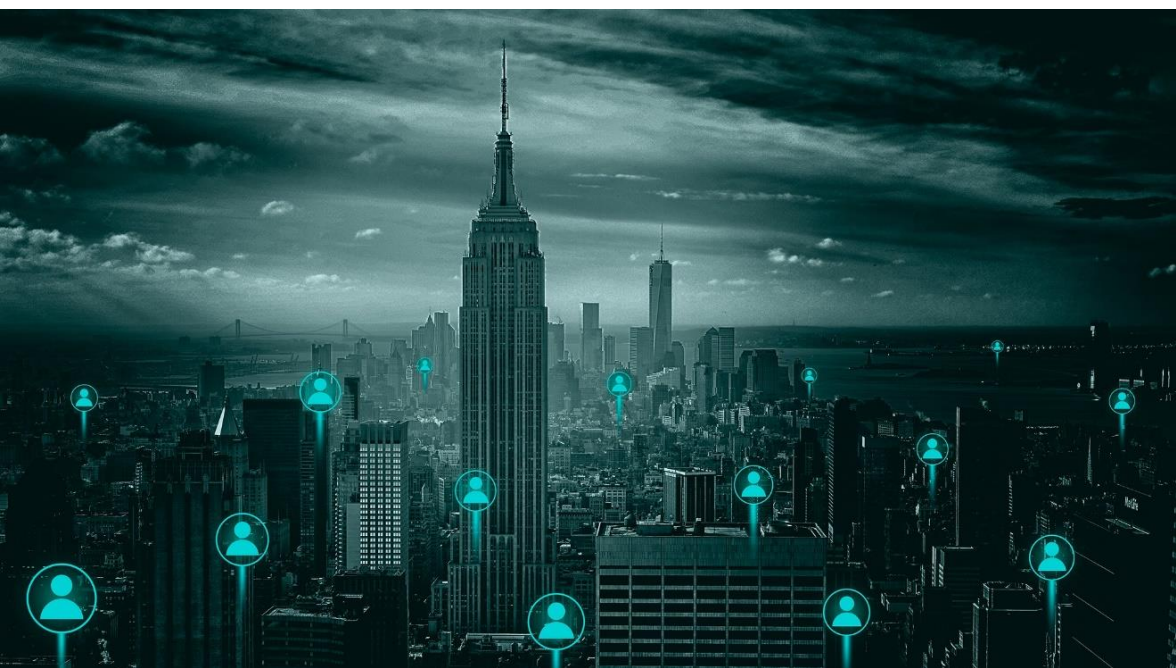

13.8 - Billions of Innovators

The brilliance of humanity living on earth is that there are billions of minds walking the planet, and each one has distinguished characteristics and all resemble uniqueness, everyone has something special about them, and each person on the planet earth has something incredibly brilliant to share with the rest of the world, we can say that there are billions of innovators on earth and each one possess unique ideas, that can improve and change

the world towards betterness.



13.9 - Millions of Brains Against Common Objective

As we all have heard that two brains are better than one, just wonder millions of brains working for a single solution and common goal, and brainstorming unique ideas to turn the Free Source of Energy Technology into a reality, this type of struggle can turn out to be a miraculous one, that can truly turn the Free Energy

Concepts into a reality, the concept of building a platform where people from all over the world can join the common struggle of developing Free Energy Solutions can prove to be very beneficial for everyone, humans can build wonders, if work together with determination to achieve something for the greater good.





14.0 Common Goal

The main purpose of giving the world's innovators an online community platform is to unite the minds to achieve a common goal of turning the Free Source of Energy Concepts and Technologies into a reality, when millions of people will work on a common objective then they can get miraculous results and massive achievements, the primary benefit of bringing millions of mind is that they all can do years of work in months and days, and with incredible perfection.

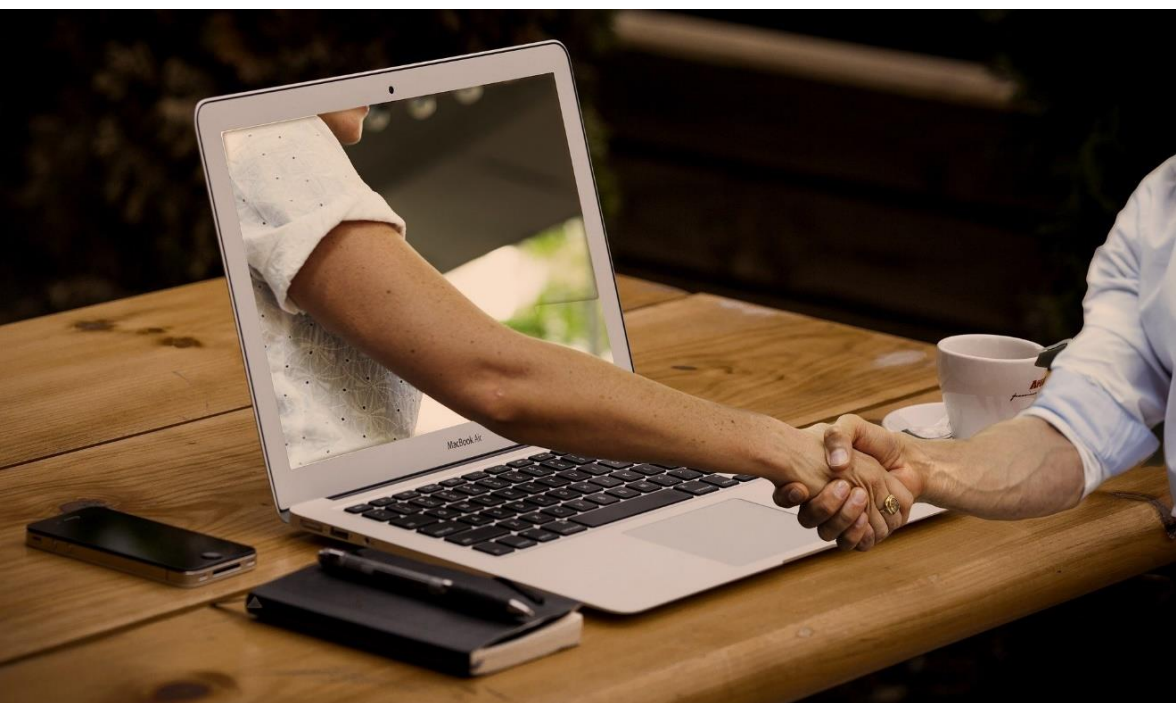

14.1 Online Community

Building an online community for Free Energy Struggle will be one of a kind, and it will be able to achieve astonishing results that will revolutionize the world economies and will empower the nations around the globe, with those tools and projects that will fill the gaps of Energy Crisis and load shedding, that has been one of the major issues for poor societies around the globe.

Millions of innovators around the globe will come together to draw a bigger picture of building incredible Free Energy Solutions and Creating an innovative landscape that will support Free Energy Projects and will battle the Energy Crisis.



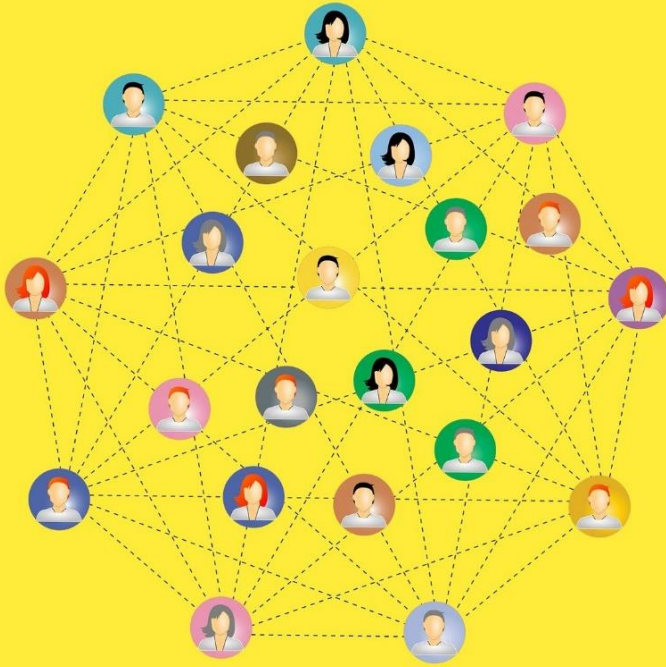

14.2 Public Participants

Millions of participants around the world will join the Free Energy Struggle, and all nations around the world will be invited to become the part of Free Energy Initiatives, that will benefit all economies around the globe, and will solve major issues of Energy Crisis, Global Warming, Air Pollution, Oil Crisis.

One of the primary motivations for the participation of the global economies, and business industries will be the revolutionary change, that the Free Energy Struggle will bring to end the Power and Energy Crisis, that the world will face soon after the global Oil resources become scarce.





14.3 Participants Submission

Anyone in the world will be able to join and participate in the Free Energy Struggle, and the online community will have various options made available to them, the innovators from around the world will be able to submit their works, related to Free Energy Concepts and Technologies. There will be no charges for participating and

joining the community, and anyone with an interest will be able to join.

The reason why anyone in the world will be able to join the community freely is that humans have innovative tendencies, imagine a person living in the rural area might be having something important to share as feedback or contribution that can bring a big change and support in developing a global solution because that person might have experienced something, which people living in the urbanized world, may not understand, or are unable to discover early.

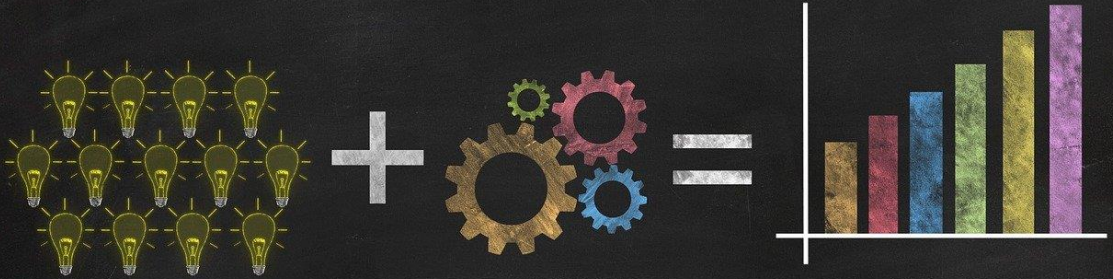

14.4 Community Contribution

The Free Energy Community will be able to sort out difficult problems easily due to the constant cycle of contributions by millions of brains working together as a global remote team. Imagine someone has an outstanding idea but that idea is incomplete due to some lacking component, assume the person who came up with the concept needs some help from the community, and for that reason, he shall share his work at Free Energy Community, where millions of

people around the globe will help him create and put together the missing puzzle, by developing the required component, and by helping each other, the community will be able to achieve many outstanding and remarkable innovative solutions, that will revolutionize the world.





14.5 Concept and Research Contributions

The community of global innovators will contribute their concepts and research works that will help the community members in innovating remarkable solutions, imagine millions of people contributing their research works, for developing Free Energy will prove to be a work at the faster lane of progression for entering into the new world of Free Energy.

The Free Source of Energy Online Platform and Community will contribute to developing Free Energy marketplace, and Creation of the largest Free Energy research database directory, from where industry leaders, and people around the globe, will be able to obtain licensed works.



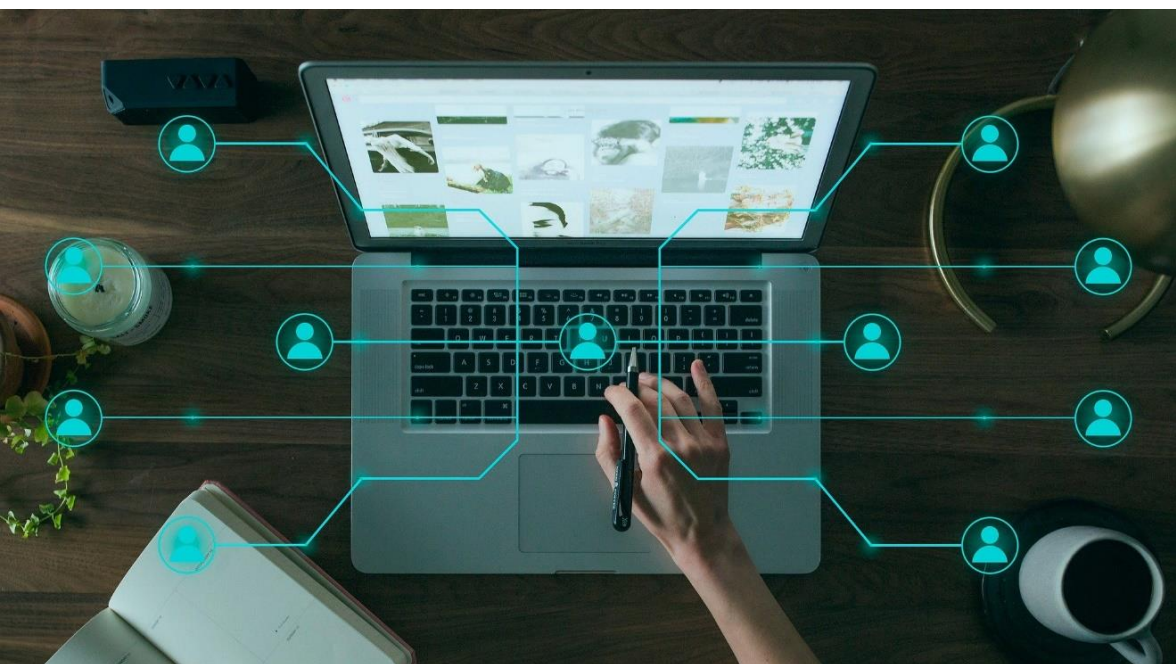

14.6 Digital Rights Management

Free Energy Platform will give the community members options to enroll in digital rights management, all the published research and materials will be protected by digital rights management(DRM) under various laws.

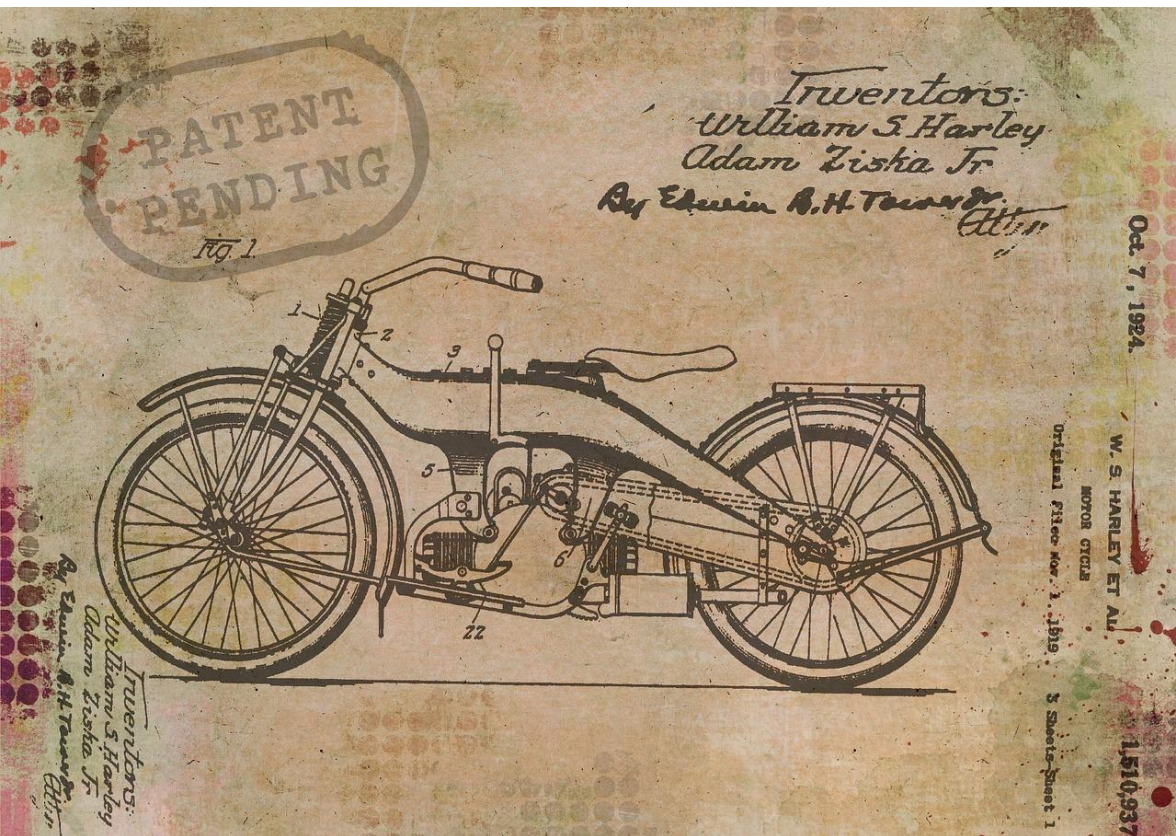

14.7 Patents Enrollment and Protection

Free Energy Platform will give the community members an option to enroll and register their works in patent protection schemes, every contributor will be given options to protect their works and obtain patent rights.

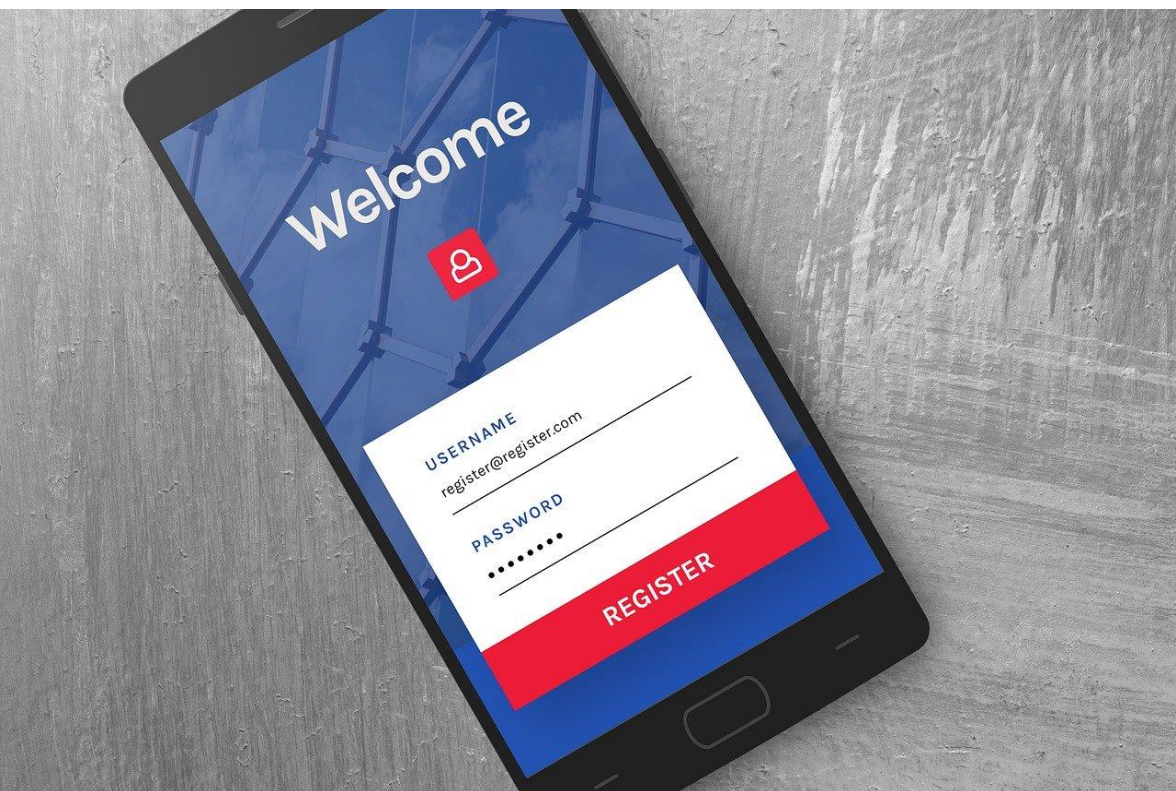

14.8 Flexible Patent Registration

The Free Energy Community will be given flexible patent registration options, with a smooth and easy process for everyone who wishes to register their works in patent protection, a special patent protection system will be built inside the Free Energy Platform, where community members will be able to register their works and obtain patent rights.



14.9 Project Support

Free Energy Platform will ensure that the innovators' voices, will get heard by the supportive community, and the contributors with outstanding research and projects will be able to gather enough support in a form of contributions, fundraises or media publicity, that would make projects stand, and people from all over the world, will be

given the opportunity to invest, in the Free Energy Projects, thus innovators will be supported in achieving their various project goals.



15.0 Fundraise

The Free Energy Platform will have its own fundraising system, that will enable the community to seek to fundraise from people around the globe, in a more efficient and reliable manner. anyone with an

innovative concept and solution will be able to create their own fundraise profiles, with options to share it with the world, with attractive invitations by choosing tempting invitation templates, community members will be able to create their appealing profiles with a variety of multimedia options like videos, music, documents, and file sharing, and plenty of options to communicate via private chats, comments, feedbacks or with options to reach the contributors at their given contact information.





15.1 Fund Contribution

Free Energy Platform will have a gathered capital, that will be made available for contributions, as global fundraises will take place to support the Free Energy Struggles, the most innovative, desired, and best-rated projects will be allocated special funds for supporting them, and to make the projects fruitful.

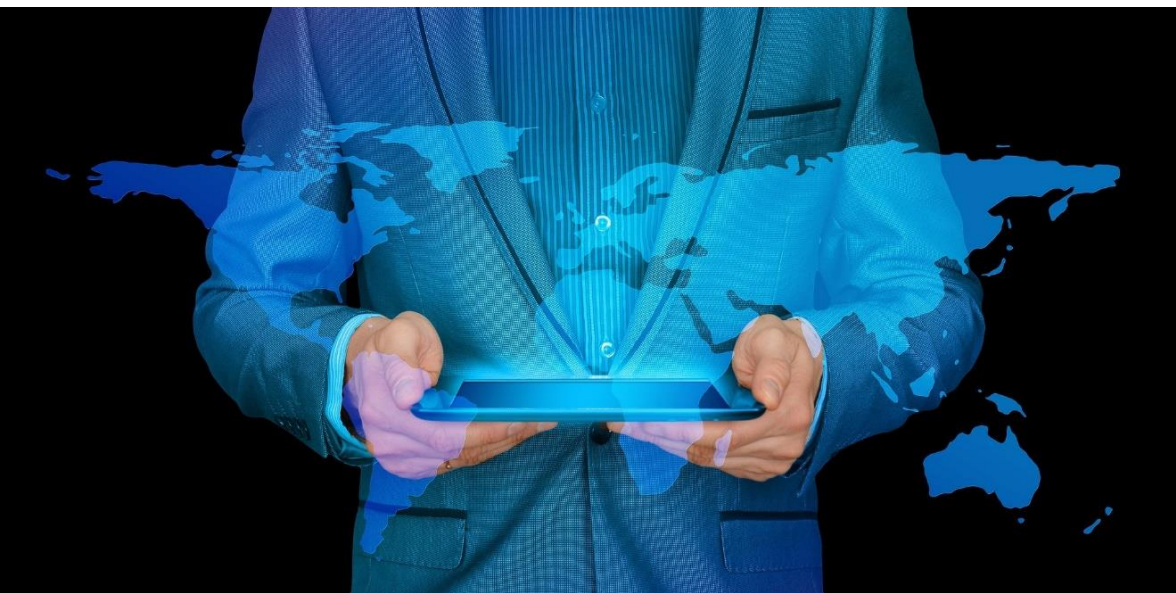

15.2 Supervision and Management

The Free Energy Platform will perform supervision and management of millions of innovators from around the world, every submission by the contributors will be moderated, all the user-generated contents, forums, and topics will be moderated against violation.

The management will work smart to enhance and upgrade the Free Energy Platform, all participants will be smartly managed, every contributor will be able to

seek help from the platform admins, and will be supervised accordingly.

Managing the Free Energy Platform Initiative will include, Digital Right Management(DRM), Patent Management, Moderation, Policy Making, Backup and Maintenance, Handling, Upgrading and Managing of Core Features, Configurations, Functions, and Settings, and Feedback and User Management and Compliance and any Task Related to Free Energy Platform.



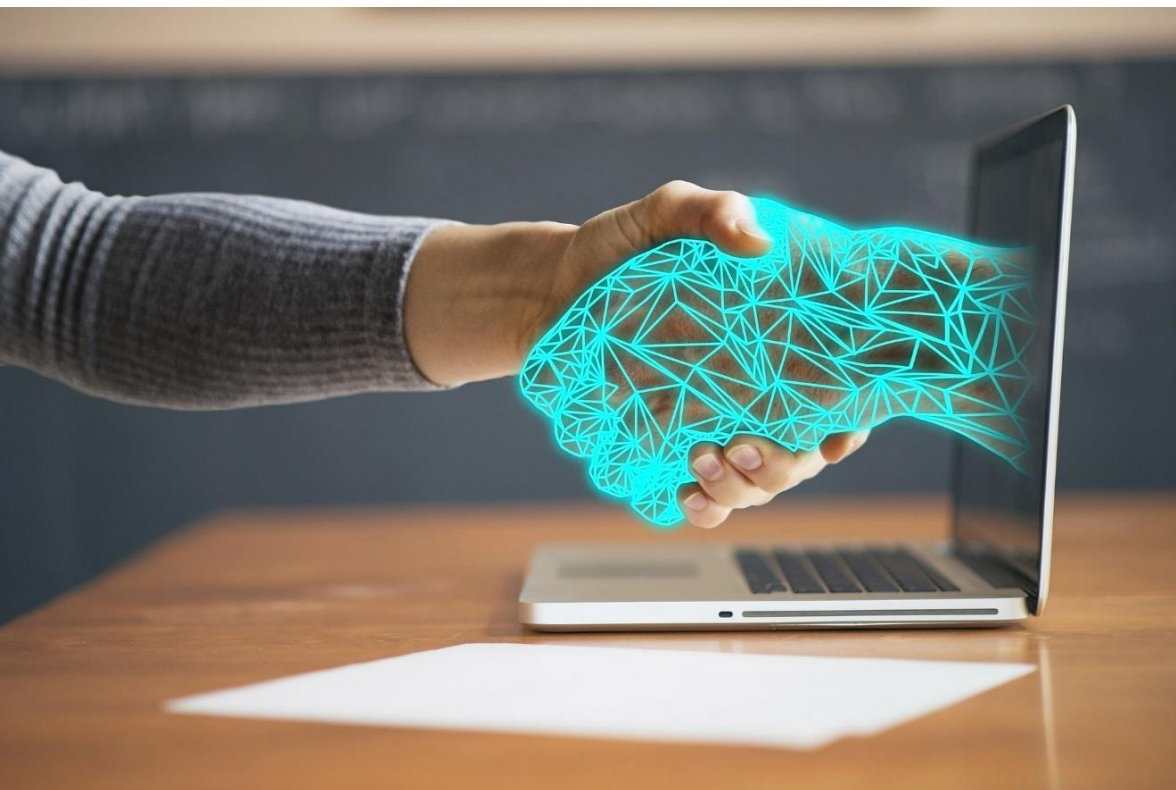

15.3 Types of Offering

There will be different types of offers made available to the general public, who wish to obtain a license for usage of intellectual properties contributed by the community of innovators, some of the offerings will be, License Subscriptions, as a Basic License, Advance License, Elite License.



15.4 Licensed Works

Every contributor will be given an option to sell and display their works, and entire portfolio as paid intellectual property, for example, anyone will be able to sell their work freely or with some fee, or by enrollment into a reward system for commission bases like affiliates, subscription or licensed works.



15.5 License Subscriptions

The public will be given an option to obtain the licensed work by enrolling into a subscription model, for which they will be given options to get future updates, and easy renewals for their subscription packages, for the offered products, solutions, and materials by any of the community contributor.

15.6 Basic License

There will be a variety of licenses made available to the public and one of them is the Basic License, in this type of offering the limited benefits will be provided like single product usage or limited usage scheme.

15.7 Advance License

In the Advance License offering, the public will be given more benefits than the Basic License, this type of license will give an additional advantage that otherwise will not be given with the Basic License, some of the benefits of Advance License are more than one end product, no cap on usage and sold products.

15.8 Elite License

The Elite License will be for those who wish to resell the product with customizations, and this type of license will be usually more expansive than the Basic and Advance

License, but it will suit those who wish to resell the products, solution, and materials with their own customizations.



Affiliate
Marketing

15.9 Affiliate Commission

The general public will be given options to promote all the products and services, for the sake of earning profits, anyone will be

able to become the affiliate freely, for the sake of earning commission against the successful referral sales generated.



16.0 Remuneration

There will be more options made available for the contributors to earn remuneration against their works, and other than the subscription, and license model, a reward system will be implemented, that will make

the contributors earn with long-term and short-term agreements between the Utilizers and elite customers.



16.1 Reward System

In the Reward System, the community members will be given an option by the other members to become the contributors in their projects, for sake of earning

partnership and to enjoy mutual benefits, and recognition in developing and supporting projects.

The reward system will be simple, for example, if one guy started the project and others supported, then the contributing parties will become the partner in profit, and will get recognition of contributing innovator.





16.2 Royalty and Commissions

All the contributors at Free Energy Platform will be rewarded in a form of royalties, and commissions earned, and from the generated sales profit, Founder and contributors of the projects will be given recognition against their works done with scrutiny.

16.3 Creating the Right System

To create the right system, it is essential that the Free Source of Energy Community Platform will be made available, to everyone without any kind of discrimination among the nations around the world, the Free Energy Initiative slogan will be, "Creating A Brighter, Better and More Sustainable Future for the World".





16.4 Free Energy Initiative Slogan

The Free Energy Struggle is not for entertaining a single nation or restricted to those countries that participate and contribute, but it is an initiative that will benefit and support all countries in the world, regardless of participation or not, which means, if only one country participates and contributes its resources,

then the ultimate solution and final product will be made available to the rest of the world, without any kind of restrictions, and that is why this slogan is given, "Creating A Brighter, Better and More Sustainable Future for the World", this statement includes and declares that the primary purpose of Free Energy initiative is to improve and support all the future generations in the world, regardless of which race, color, or nation, and what civilization people are from.

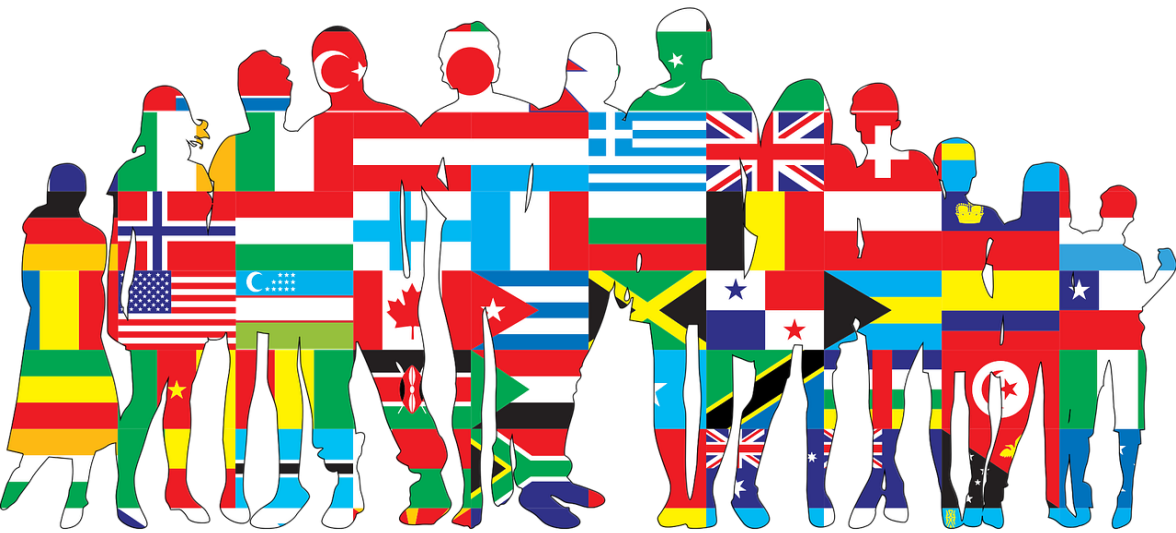



16.5 Fair and Positive Economy

The Free Source of Energy Platform and initiative will be based upon Fair Play, and building a Trustworthy and Equal Opportunity Community, for just anyone in the world, regardless of their age, race, color, gender, sex, or country of origin, nationality, or any differential characteristics, mental or physical disability, it will be an equal opportunity initiative, and everyone on the planet will be

invited to join the struggle without paying any monetary fee, and totally free of cost.





16.6 Global Participants

The Free Source Energy Platform, will be opened to everyone in the world, and not just adults but minors will also be able to become part and contribute their talents, the reason why all age participants will be accepted is that every age has something important and unique to share, for example, a kid living in the far-flung area of the world, may have experienced something special, and his/her highly creative mind may ignite the spirit of an innovator from a very young age, kids have very high imaginative skills, they are unique in creating a bigger picture, imagine a kid drawing a rope or stairway to the moon, it may sound unrealistic but there is a motivational aspect to it, thus, the kids shows up in a very hilarious, yet informative and creative way, and they might be able to support the Free Energy cause pleasantly with their unique tendencies.



16.7 All Nations Participations

The Free Energy Struggle will be opened to all the nations around the world, and all nationalities will be welcomed, in-fact the spirit and the policy of such a historic struggle should be, don't belong to any country, still very welcomed, this humane gesture of acceptance will prove to be one

of a kind and will ignite esteem passion for innovation, and long-term commitment and sustainability, if you accept people with open-arms and without any kind of discrimination and restrictions, then that positive impression will result in harmonious outcomes from the community and shall encourage a more stable and peaceful community building, that supports and communicates a common cause in a more determined and committed manner.





16.8 Easy Accessibility

The Free Source of Energy Platform will be easily accessible and available online globally, and its smart applications will be available for all devices and on every major Application Stores, for example, Microsoft Windows, Google Play Store, Apple App Store, and Amazon Appstore, or Smart Device Application Marketplaces, Like

Smart TV, Android Tv, Tablet, Portable Devices Windows Phone, etc.



16.9 Website platform

Free Energy Community Platform will have the web and mobile apps version available for the public, the web version will have interactive and responsive design, the platform will be built using latest technologies, imagine a platform that is protected by Oracle Enterprise Level Solutions, and has Microsoft Azure or Amazon AWS servers, which can handle millions of visitors and constant users at a

time, one of the main reason why bringing together top technology leaders for Free Energy Struggle is that, they can provide adequate and essential resources, which help in creating a powerful online platform, imagine world's top technology leaders working together on a mission to provide the best solution for building the Free Energy Platform, for the world economies to battle the Energy Crisis, if the top companies come together to solve bigger problems, then they can provide enough resources, that can help innovators around the world, in achieving their goals of developing Free Energy solutions, and Technologies.



17.0 Mobile App Platform

The Free Energy Platform, will have its mobile applications available on various major app stores in the world, the application will be free to use and it will consist of all features that the web version will already have, the mobile version will have a variety of important features like, chatting, messaging, notifications, easy

signup, and fast login, identity verifications, and the mobile app version will also have dashboards related to managing projects, there will be a variety of dashboards, from where the users will be able to see the essential details regarding their online profiles and activity, such as analytical data, about the profile visits, audience demographics, and one of the major features will be accessibility to the Free Energy Marketplace from where the contributors will be able to manage their seller profiles.





17.1 Universal Device Support

The Free Energy Platform will be available and made compatible with all devices present in the world, in-fact the mobile app version will also have the light version which will share all the essential and complete features, yet it will have faster usability and higher performance over the outdated and obsolete phones, so that the communities from the rural, and unprivileged nations, will be able to use the platform, same as the ones living in the privileged areas of the world.



17.2 Understanding Innovation

The Free Energy Project will require universal cooperation, for example, the essence of building a Free Energy Platform is to bring together the world's innovators, or just anyone who wishes to contribute to the Free Energy Projects, innovation is a never-ending process, and it requires an enormous amount of time to evolve if one person tends to innovate something and keeps improving it, then that guy needs to dedicate his/her entire life to develop

something remarkable, however, if millions of people work on the same subject, then they can improve it in a matter of days and months, in easier words we can say that in the past, a remarkable innovation needed a lifetime of hard-work, but in the today's world people can achieve years of work in a matter of days, due to smarter technologies, and abundance of talent that is available.

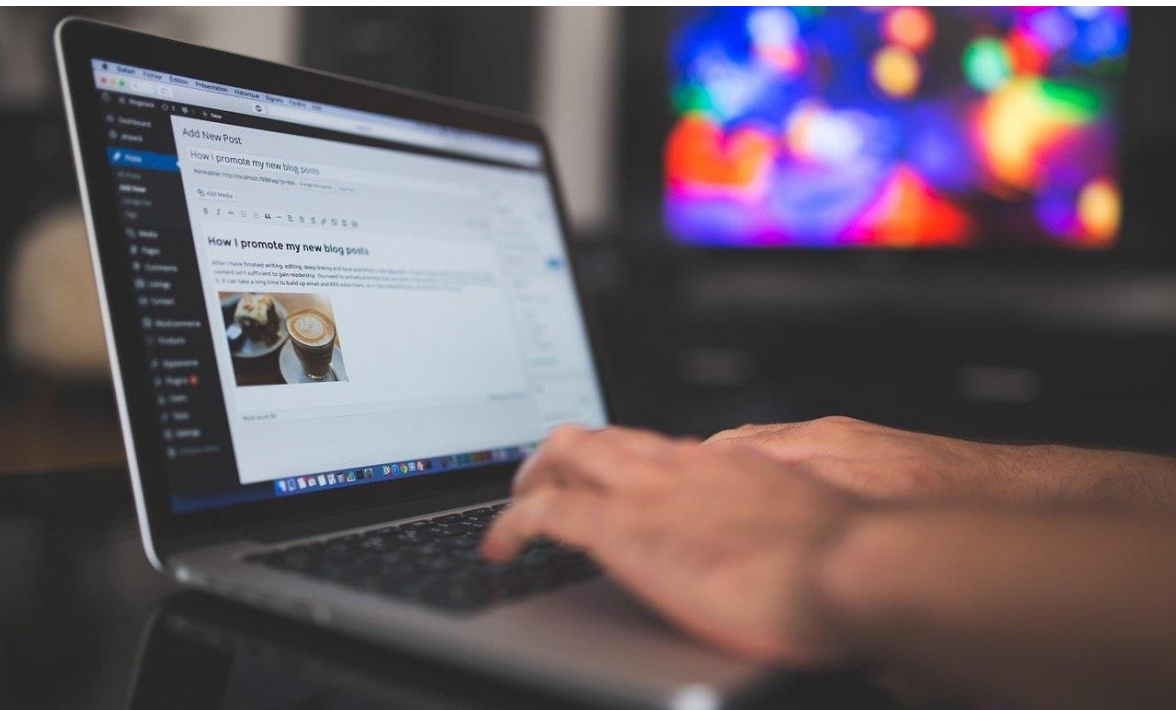



17.3 Project Timeline

The project timeline will show the project history, and display the information related to the works done, and how much did the project evolved. Every project at Free Energy Platform and Marketplace will have its own project timeline, and it will be very helpful and shall indicate crucial details

about the project like number of contributors and their work history and period of contributions, the project timeline will show on the hourly, monthly, semi-annual and annual statistics, and the project owner will be given options to show and hide some information they like to, for example, the project founder will be able to hide, location, and personal details, however, some information will remain public for scrutiny reasons and transparency concerns, like fundraising history, a number of sales, feedback, rating and comments, bug issues, mechanical failures, public voice for improvements, and seller and founder communication ratings.

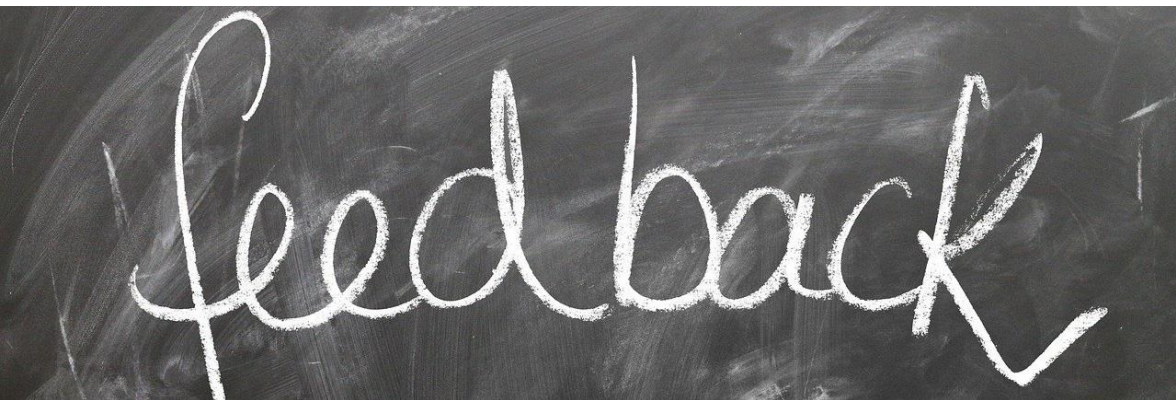

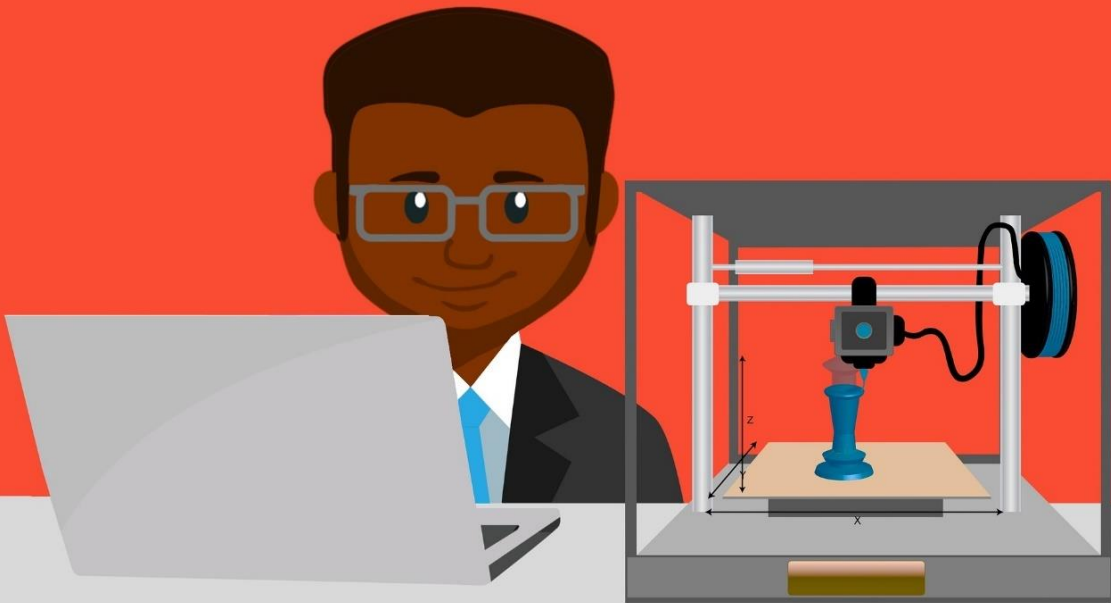

17.4 Prototypes Creation

The Free Energy Platform will have a special project management workspace, the project creators will be able to contribute their prototype sketches, mechanical drawing, or other sophisticated technical and technological drawing plans, with the option to call out and invite others to contribute the original plan, the project founder will be having the option to make

the project open for the public or keep it private for selective contributors and their own network or contacts.

The major benefit of Free Energy Platform will be that, millions of people will join the community of innovators, and shall help and support the cause, which will make Free Energy Technology a reality in a short period of time, we can assume that if millions of people work on building Free Energy technology, then they can release a working prototype in a matter of days, months or only a few years.

A short demonstration of Free Energy Platform can be, Ahmed working in a garage heard about the Free Energy Struggle from some source, He then went home, and all of the sudden his imagination started to conceive an idea, he then became a bit excited and drawn his concept on a piece of paper.

He becomes captivated with his own ideas and keeps improving his sketch, however

after Ahmed completed drawing his concept, he decides to contribute or submit his project on Free Energy Platform, his main idea is some kind of machine, that he thinks can generate Free Energy, he successfully creates his project page, but after a while, people start checking his submitted work online at Free Energy Platform, and then many community members approach him and request to contribute to his work for mutual benefit, or for the sake of support or contribution.

People start commenting on the project and initiate a conversation about what can be improved, Ahmed then decides to enroll other contributors on great terms, which then made the project evolve, after dozens of people contributed to his work and improved it, then the project itself starts attracting more contributors, and finally someday, a working prototype has been released and the community efforts, resulted in fruitfulness, the project owner Ahmed, is ready to sell the usage license, from which the public and industry leaders,

will be able to utilize the master plan, but they need to get the license first, the project contributors get their piece of the profit, according to the contributed works, and the terms they agreed with Ahmed the founder, the profits are distributed fairly between all the contributors of the project, and the community keeps on improving the original project to take it to the next level.



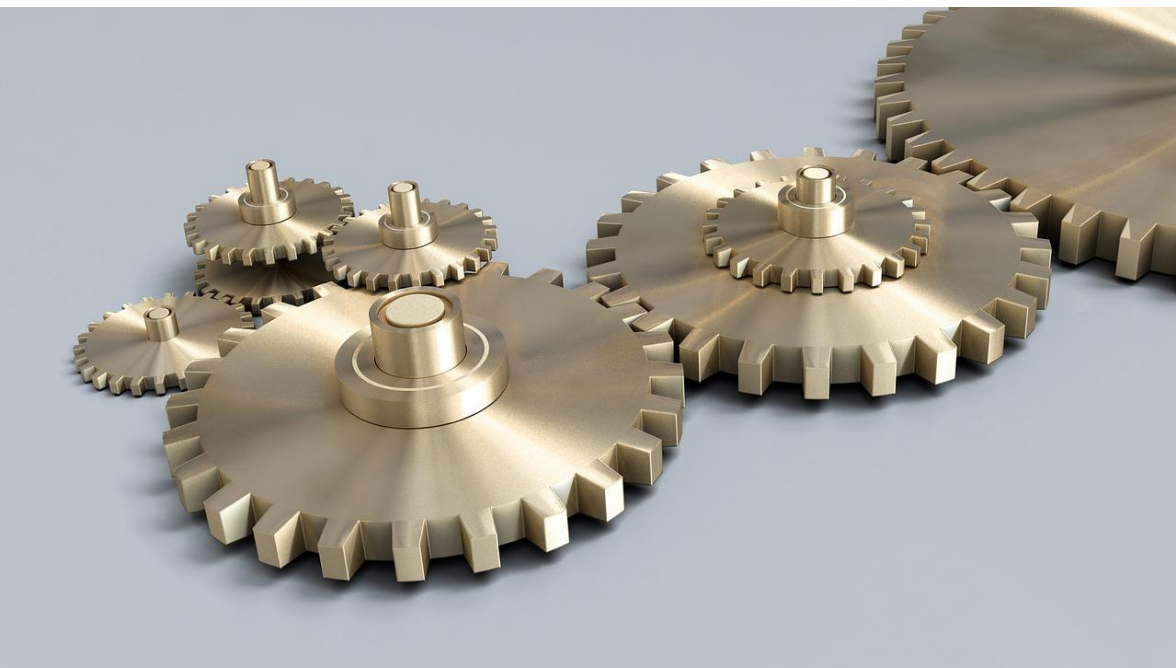

17.5 Working Prototypes

The Free Energy Platform will give every member of the community, the opportunity to create their portfolio containing the prototypes, everyone will be able to establish a prototype work, and will be able to invite the community members for support.

Community members will be able to seamlessly upload their mechanical, and technical drawings, and research works, and data files, related to the prototype, they will be able to give extensive documentation, and masterplan for the public to download and fetch project so that the community can better understand the project and contribute towards the same.





The Free Energy Platform will be compatible with various, file formats and extensions, for example, it will support the AutoCAD, CAD, Illustrator, and Photoshop files, or any other that supports the creation of prototypes.

The Free Energy Platform will have its Visual Workspace, or Visual Composer or Visual File Opener, for example, people will be able to see the uploaded 2D and 3D projects in the workspace and will be able to open the project files, and render them in various dimension and angles, the same way we see the project in the AutoCAD and CAD, and for enabling the same features, a contribution and collaboration, with the top software developers like Autodesk and Adobe, would be very beneficial.



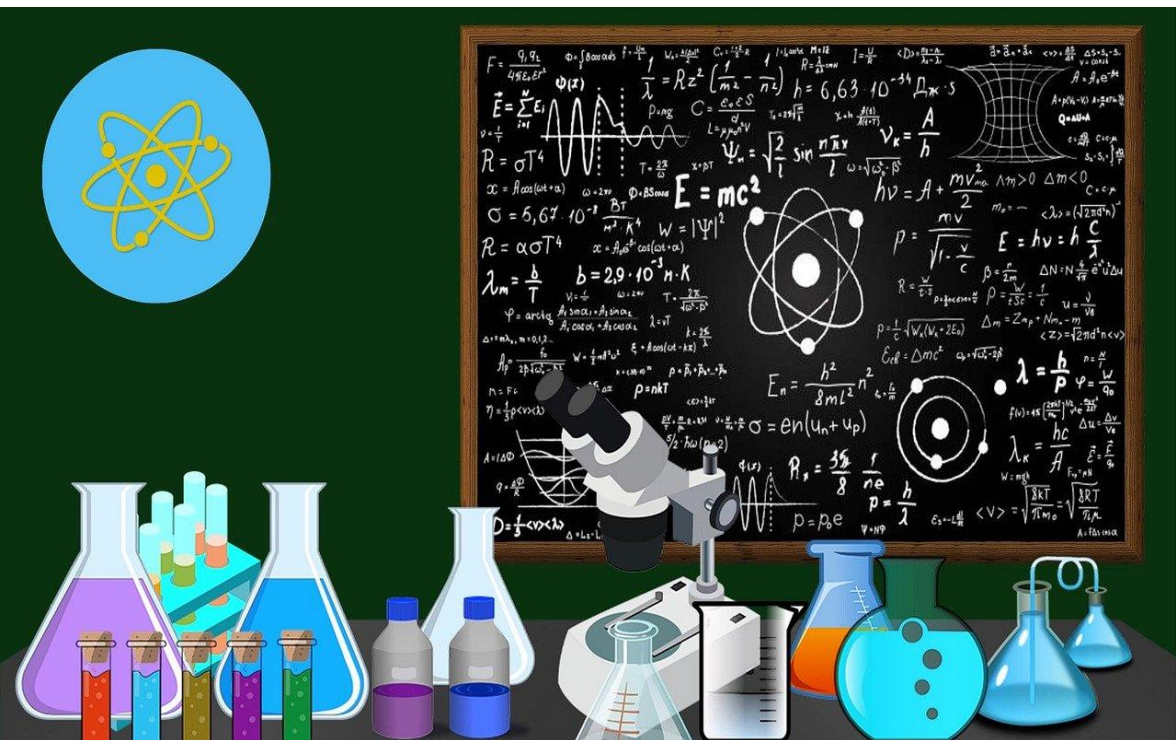

17.6 Innovators Lab for Improvements

The Free Energy Platform will have unique features available for contributors, and one of the handy areas or built-in workspace platform will be Innovators Lab, in this type of Lab the contributors will be able to upload and submit various versions of the original project, this workspace will be a dedicated Project Library where people of different mindset will showcase their

changes to the original project, that they previously fetched and downloaded to work on, and the creator and original author will be given the option to make the project public and accessible to the community at the Innovators Lab, where random contributors will be given options to upload assets and sub-versions, and also access to original project files and materials.





17.7 Better Versions and Upgradation

Working on better versions and upgradation will require community support and their remarkable contributions, the supportive web of the community will work on improving the existing innovations, and finding flaws in technologies, and contributors will suggest improvements and recommend crucial changes, that will give

a better vision towards building a better, and flawless version of Free Energy Projects, and their up-gradation works.



17.8 An Endless Innovation

Innovation at Free Energy Platform will be an endless journey, because once a project will be uploaded it will remain in the database for the rest of eternity, as we have heard that one man's garbage is another's a treasure, and at Free Energy Platform everyone will be celebrated and appreciated for their contributions, in-fact

the community members will have the option to preserve their deleted works because sometimes, obsolete technologies and outdated works have something important to learn from.



17.9 Invite System for Progressive Continuous Improvements

Working continuously on a project might be a very tiring task, and people often run out of ideas frequently, and for that reason,

many contributors, will move on to other projects, because many have the tendency, and an option to retire from projects anytime, that is why The Free Energy Platform will have built-in invite system from where, the original founders of projects will be able to request, any member of the community to join and work on the project, however, the community members will be given many options to enable or disable or to manage public invites.

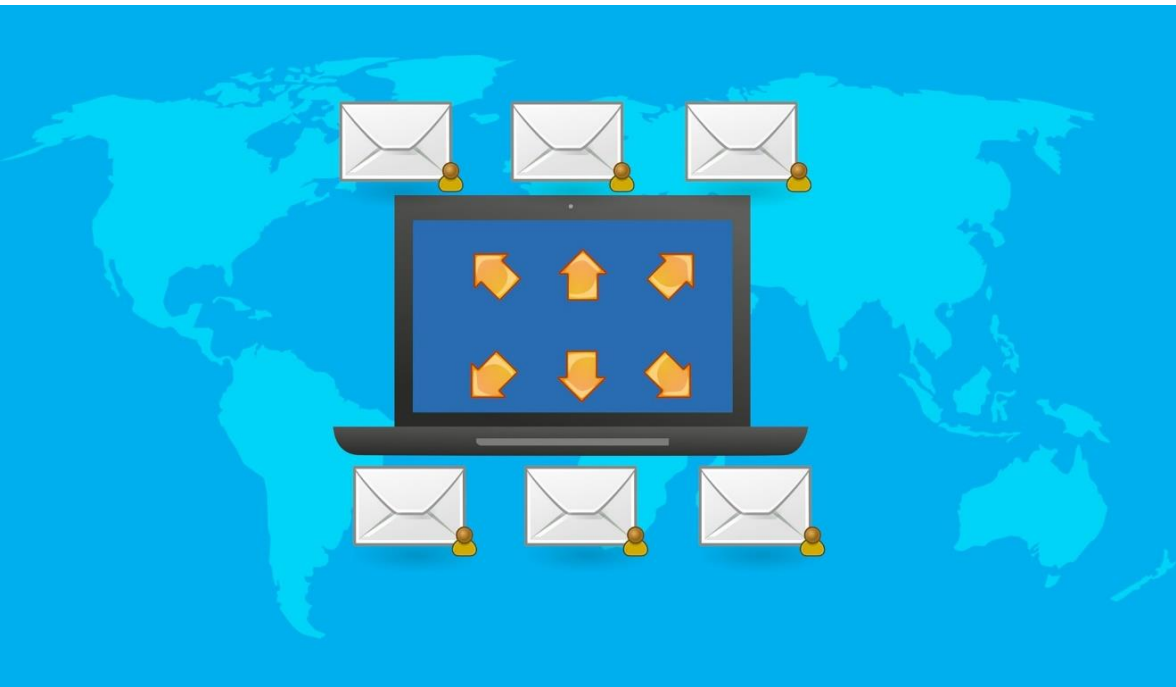

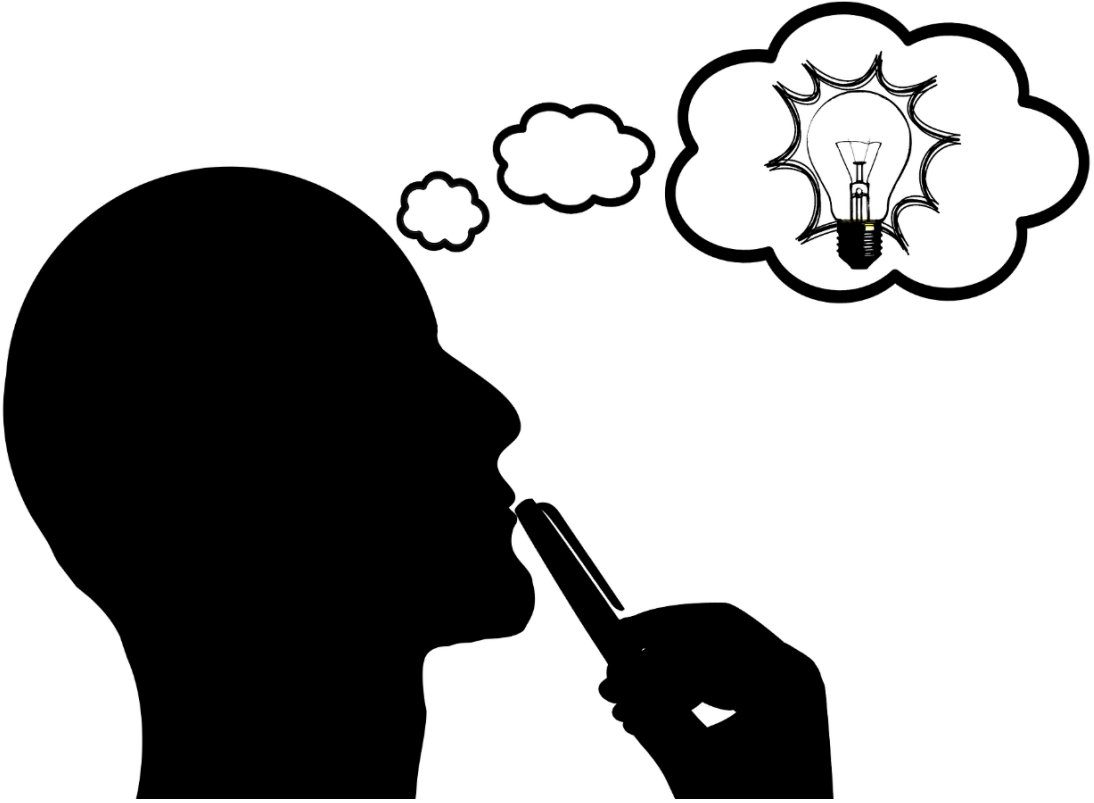

18.0 Turning Vision into A Reality

Building a Free Source of Energy Platform will be a big success for everyone, Not only the world wins but the contributors as well, The Free Energy Technology, will revolutionize the world economies, and change the direction of anticipated and devastating events, like the Energy Crisis, Oil Crisis, Global Warming, Air Pollution

and any other mentioned in this book or not, The Free Source of Energy Platform will give hope and a valid chance to save the planet from horrible and life-threatening disasters, and the Free Energy Technology, will be the ultimate outcome of building Free Energy Platform, the Free Source of Energy Concepts and Technologies will prove to be the backbone for the progression, and success of the future world, and that is why it is of utmost importance, and very vital for the survival of our next generations, as some wise guy said, Prevention is Better than the Cure.

18.1 Second Essential Part

The Second Essential Part consists of Mechanical and Technological Concepts and Frameworks and Mechanics behind building Free sources of Energy Technology.

In this essential part, the main technological and mechanical concepts and terminologies will be demonstrated, that will convince the audience, and make them realize, that Free Energy Technologies can be made into a reality.

The Second Essential Part is the blueprint for starters and innovators, to develop, and build Free sources of Energy Technology, from the concepts stage to the working prototype development stage.



18.3 Motivation

We all know that we are living in the 21st century where advance research and scientific technology, have proved to be of vital importance for human survival, the human mind has evolved to the next level, and what we can think and perceive, we can create.

The Free Source of Energy Concept is based on a belief that, in the modern age,

we can build a technology, that can generate infinite Electricity without using any kind of Fossil-fuels, Air, Water, Oils, Nuclear fuel, or any other source of fuels.

In the modern era, humans have created all kinds of complex mechanical structures, like Automotive, Aircraft, Heavy Machinery, Industrial Machinery, etc.

Having a look at Human creations, advancements, and achievements in the research and technology of the modern era, we can say that building a Free Source of Energy Technology is quite easier than we think.

Humans of the present world can build a Free Source of Energy Technology, by creating a mechanical body, that has certain loops of continuous motion or endless motion or revelations.

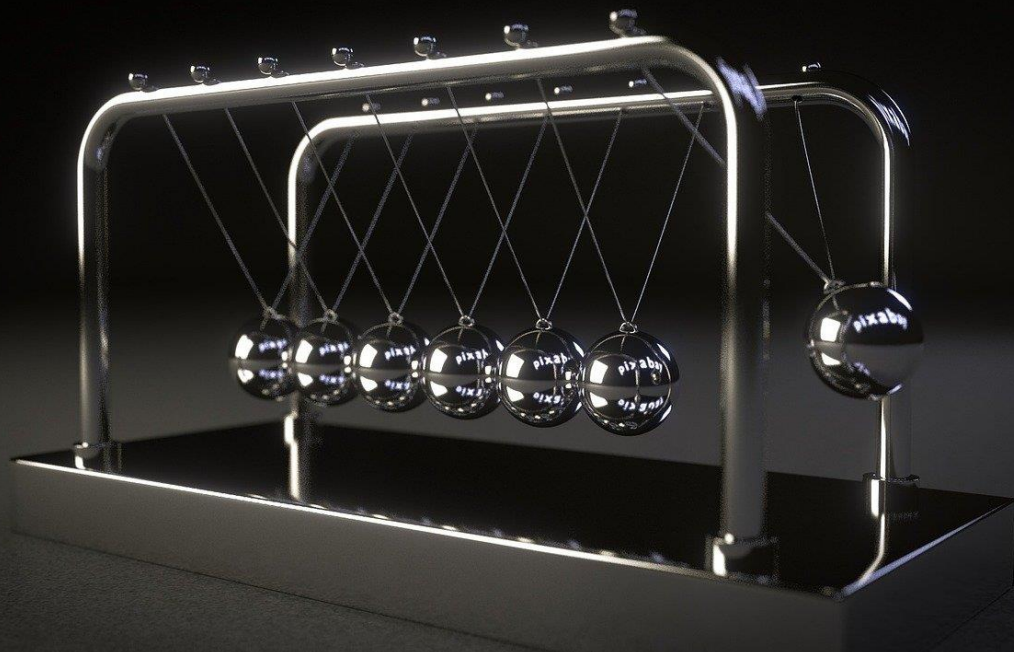

18.4 Physics

The physics behind creating a mechanical body that has an endless loop of motion is quite a fascinating thing, imagine a Spinning Top, that never stops spinning, now it may sound unrealistic because there has never been a spinning top like that, now it cannot be a perfect example, but let us assume that, if we want to create a spinning top that never ends spinning then we need to understand the science of why does it stop spinning after some time, now there

can be countless reasons, like friction, speed, gravity, etc., what if say that we can create a mechanical technology, that will restart the spinning top with an endless loop before it stops spinning.

Another great example is of pendulum toys, we all have seen Pendulum Swinging Balls, or Swinging Pendulum Man Toys or Swinging Pendulum Gymnast Toys, when we look at them, we get fascinated about their motion, for example, the swinging pendulum man starts its motion revelations, without a major use of extra force, but gradually decreases the speed and stops, what if we can create and add an endless loop of motion, by innovating a technology that helps the swinging man, in keeping his continuous motion action, the same goes for the pendulum swinging balls.



18.5 Motions

We all know that there has never been a mechanical body created by Humans that may have an endless motion or endless operation or endless action without the need for power or fuels, but due to the scientific advancement of the 21st century, we can create a mechanical machine, that

has an endless and ever-repeating action or continuous revelations by just relying on the mechanical systematic structure, in short words we can say that we can hack the motion science, in-fact in the future, there will be motion engineers, or motion specialist, which will master the motion science, not specifically the physicist, but physicist with a deeper understanding and advance education or specialization in endless motion sciences.

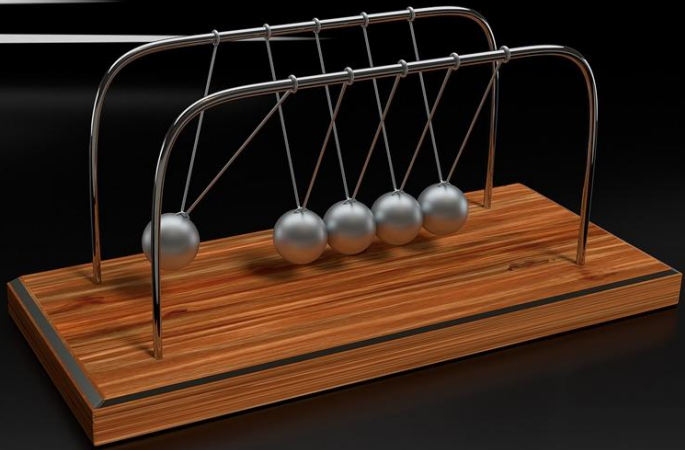

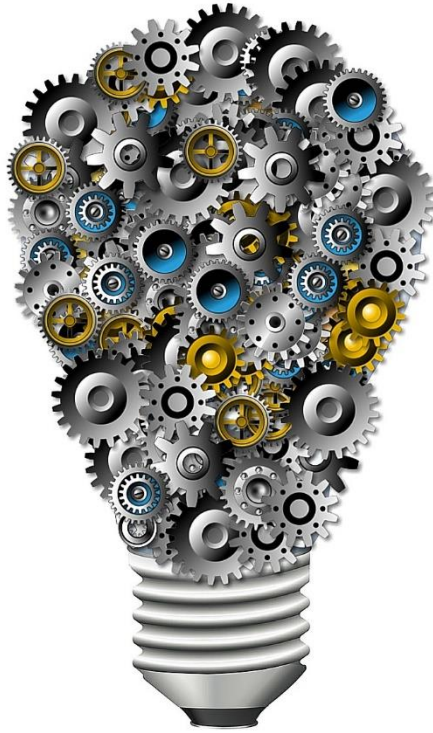

18.6 The Mechanics

In order to build Free Energy Technology we need to understand the Mechanics that make the machine work, we know that we need to create a mechanical body or parts, that can act in a never stopping actions, take for example a Car Engine, it has pistons inside which completes a cycle of revelation from starting to repeating, for example, a four-stroke engine that

performs, Suction(Intake), Compression, Power and Exhaust, in this type of engine the piston performs a revelation of actions and completes its cycles until the car is stopped by the breaking system, However, we need to create a mechanical engine that does not rely on fuels but, the engine entirely depended on its mechanical parts to support the completion of revelation.

Firstly, we need to create a body that is built in such a systematic way, that the Free Energy Engine can smoothly perform its infinite loop of action. A special mechanical body will support the Free Energy Technology's parts and components, to make them closely cooperate with each other in desired and correct way.

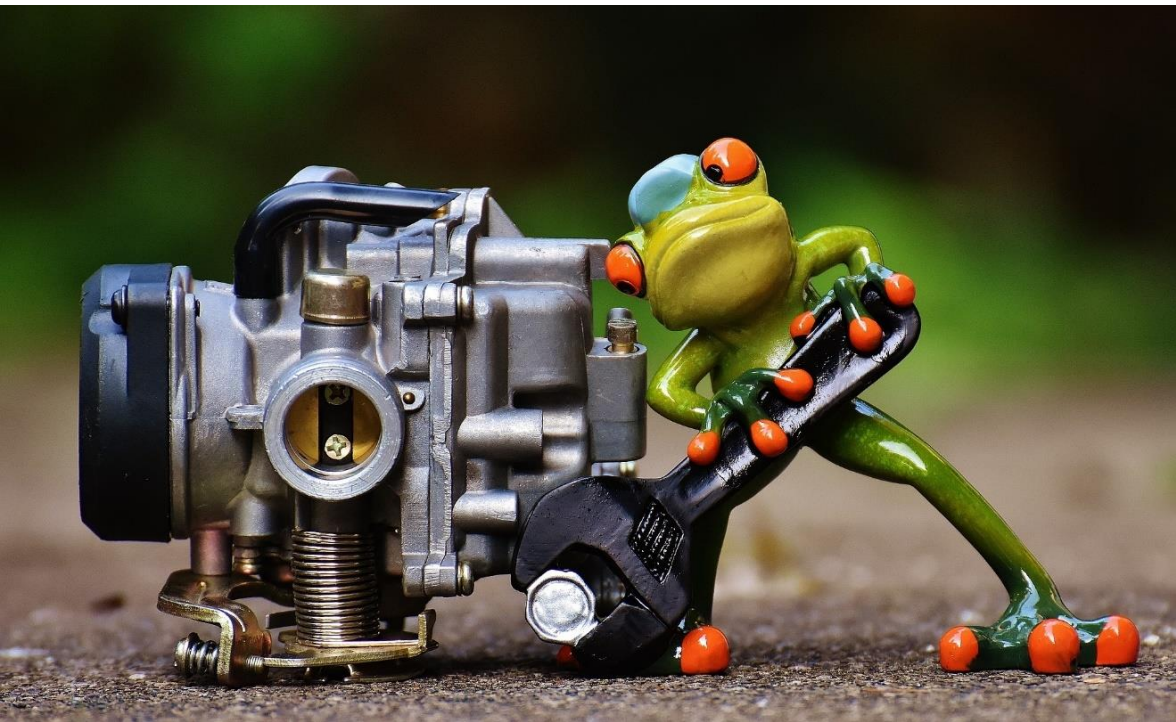

18.7 Tuning

Tuning means, arranging, adjusting, and calibrating the systematic mechanical body parts, in the right and correct way, which can make the Free Energy Engine perform smoothly with desired results.

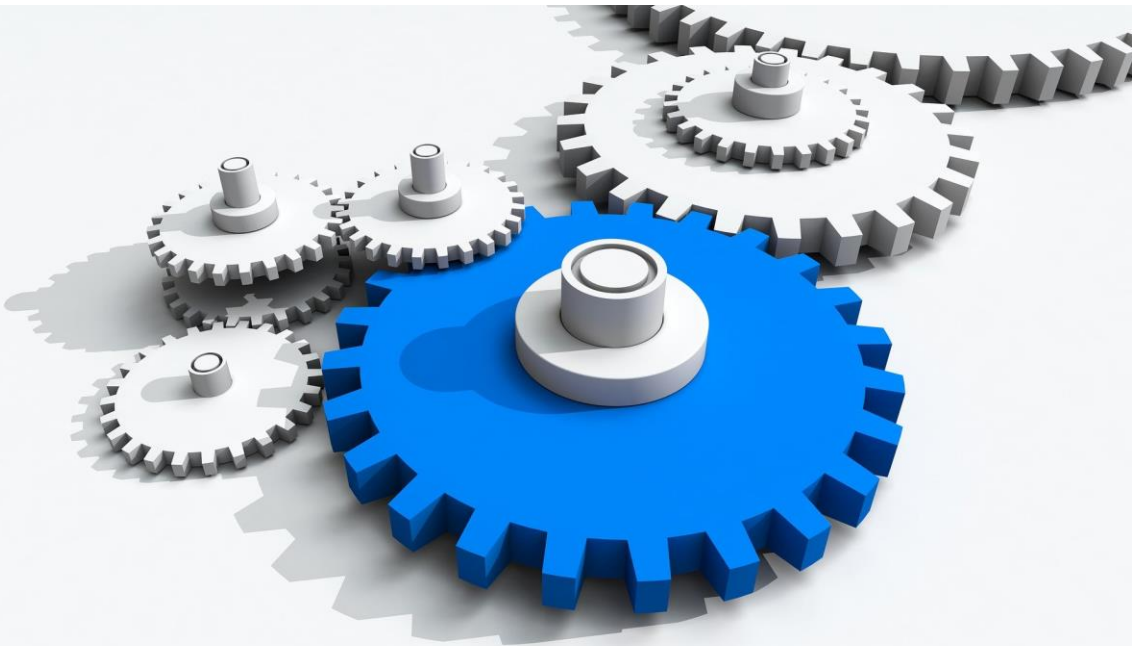

18.8 Adjuster

The adjuster is a built-in mechanism or component which helps in adjusting and tuning the mechanical parts correctly, it makes the parts move from their place into the desired ones. The Engineers will be able to tune the mechanical parts correctly due to the adjusters, this act is called machine tuning.

18.9 Loop

Loop or Mechanical Loop means a cycle of endless revelation or motion, or a cycle of action by the mechanical component, known as mechanical loop.

19.0 Looper

Looper is an additional name to Magnetic Looper and is a component which enables the loop by magnetic force exertion towards Magnetic Wheel or Magnetic Blades or Magnetic Shafts that makes the Magnetic Wheel spin, or supports and acts as a component that enables the endless motion, it is of primary importance, it can be a magnetic or electromagnet component, or a component that exerts magnetic force.

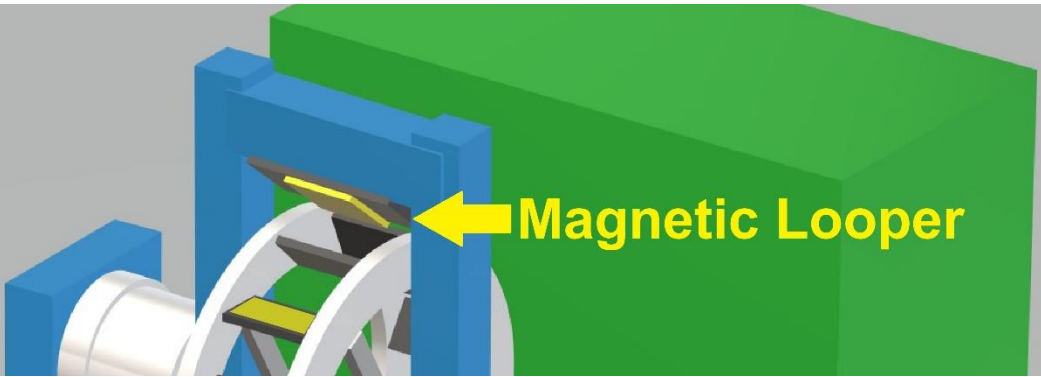

19.1 Magnetic Looper

Magnetic Looper is a component or Electromagnet component that exerts a magnetic force and applies the magnetic force towards the other components and mechanical parts to enable a Loop, the job of the magnetic looper is to exert mechanical force and to create a repulsion, or attraction between two magnetic dipoles.

Magnetic Looper needs to be built with systematic features like automatic on and off, it should become active and inactive and turn on or off at the right time, in coordination and in a sequence with the Magnetic-Wheel, and its motion and spinning and as per the revelations.

The Magnetic Looper has the electromagnet or electromagnet features and capabilities that make it turn on and off in a desired and configured systematic manner, and it needs to be predefined and set according to the needs and requirements with coordination and in a sequence with the Magnetic-Wheel.

The Magnetic Looper will exert magnetic force towards the Magnetic Wheel or Magnetic Blades to create a repulsion as the repelling action will take place when the similar side or poles of two magnets are placed together as south-end with other magnets south-end and north-end with other magnets north-end, a mechanical alignment of Magnetic Looper and Magnetic Wheel will be created where the exposed sides of Magnetic Looper and Magnetic Wheel or Magnetic Blade or Shafts will have similar magnetic charge as south pole side of Magnetic looper and south pole side of Magnetic Wheel or

Magnetic Blade or Shaft or else the north-end pole with north end poles to create a repulsion.

The Magnetic Looper's exposed side will have the same magnetic charge as the exposed side of the Magnetic Wheel or Magnetic Blade or Shafts on the Magnetic Wheel to create a repulsion action.

19.2 Force

Force is an energy, that forces components to move from one place to another, this type of force is exerted from a powerful magnet or component that has a magnetic force.

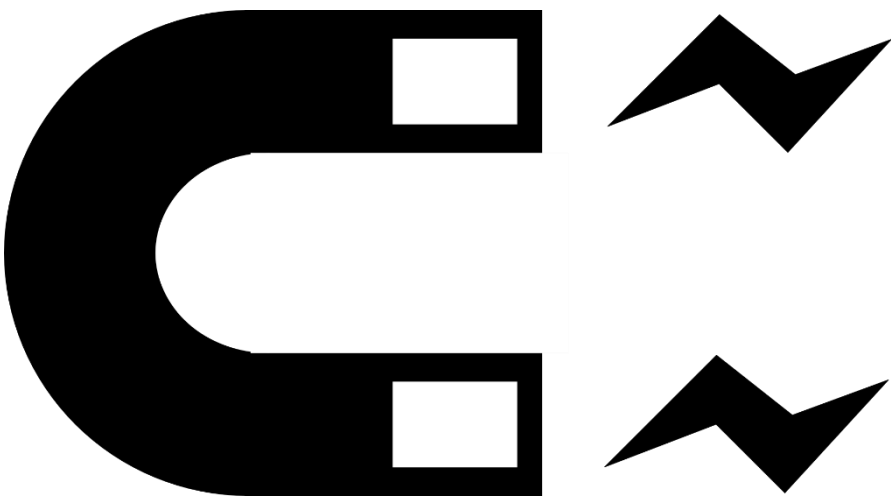



19.3 A Powerful Magnet and Magnetic Force

There are many types of Magnets like the Permanent Magnets such as the Neodymium Iron Boron and Samarium Cobalt and Alnico and Ceramic or Ferrite.

Other types of Magnets are Temporary Magnets, such as the Electromagnets which can turn on and off with a button, and

other temporary magnets used in a variety of applications like speakers, radios, telephones, computers, heavy machinery and heavy lifting, cranes, plant floors, magnetic sorters, airfields

Magnetic Force is an energy that is exerted from the magnets or components that are charged with magnetic energy or magnetized.

19.4 Looper Lever Arms

The Looper Lever Arm is a component that has a restricted motion cycle, it holds the magnetized components and other parts, that pushes and forces, other mechanical components to move, for creating and enabling the cycles of the loop, and completion of revelations, of mechanical body parts in a systematic way, for example, a component that moves the Magnetic Looper by enabling it towards the Magnetic Blades and Magnetic Wheel and then disabling it by moving it back.

The Looper Lever Arm can be an automatic and manual, but it is an optional mechanical component or part, however only its idea and concept are given in this book because according to the main concept for Free Energy Engine Model the Magnetic-Looper does not need a Looper Lever Arm part as it has the capability to turn on and off from a fixed position as an Electromagnetic or Electro-Permanent Magnet in a close and correct range with Magnetic-Wheel.

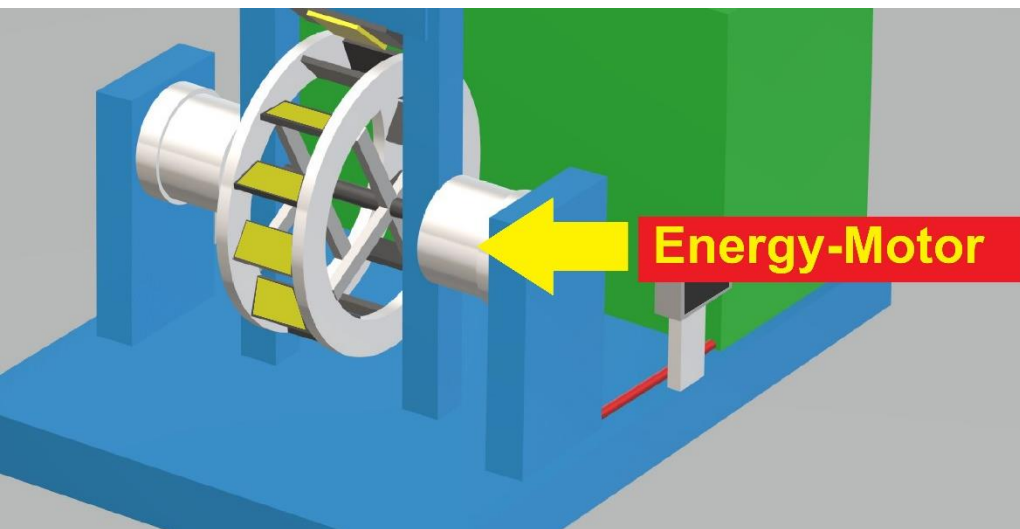

19.5 Energy Motors or Power Motors

Energy Motors or Power Motors are the primary motorized parts, that are responsible for generating energy during an endless loop of motion or continuous revelations of mechanical parts, of a Free Energy Engine in a systematic and planned way.

19.6 Energizer

Energizers are all those technological and mechanical components of Free Energy Engine, that can exert and process electrical energy, these can be motorized equipment's and components, and motor parts, capacitors, voltage adapters, and components that support, energy storage, and processing of electrical power generated, these can also be the components that re-magnetize the magnetic components or magnetic loopers.

19.7 Magnetizers

These are the essential components that have the ability to recharge magnetized components of Free Energy Engine, these are essential for the durability of powerful magnets or Magnetic loopers, to keep them magnetized.

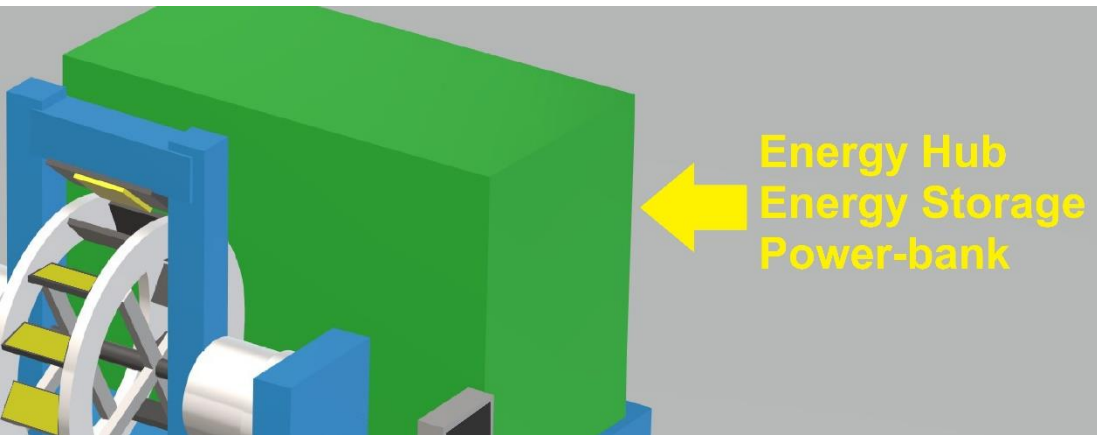

19.8 Energy Storage or Power-banks

Energy Storage is technological equipment, that plays the part of being a Power-bank, and stores the energy generated by the Free Energy Engine. Energy Storage Equipment will have high Power Storing Capacities and shall be made according to the requirements, for example, a Car will have considerably smaller Power Storage than the Airplane.

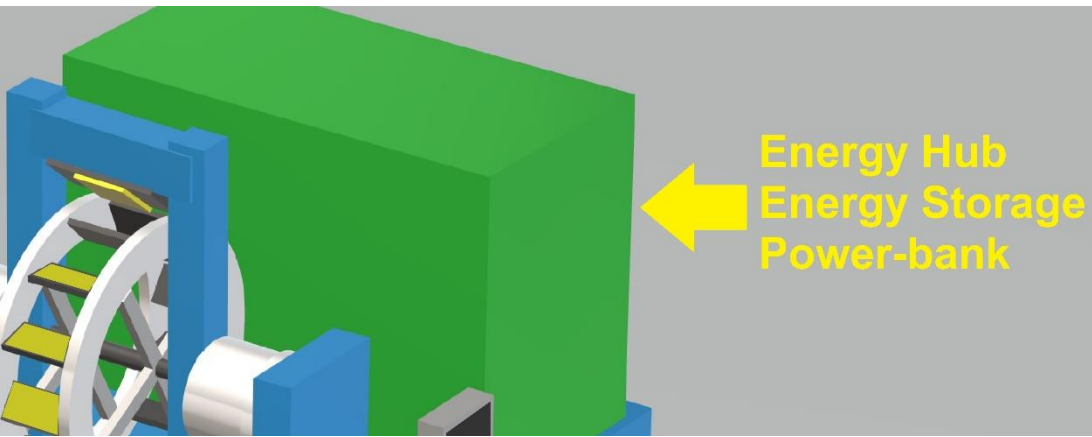

19.9 Energy Hubs

Energy Hubs are the compartments that will keep the Energy Storage Power-banks, the Energy Hub Compartments will carry Power-bank slots, for making the replacements of Energy Storage Components easier, faster, and seamless.

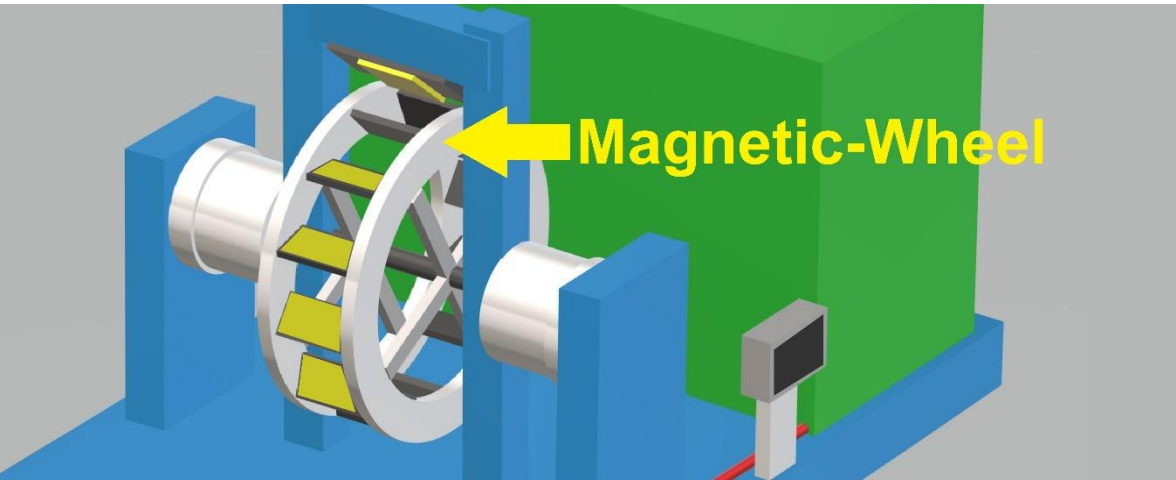

20.0 Magnetic Wheel or Free Energy Wheel

Magnetic Wheel or Free Energy Wheel is the round mechanical component, that has Magnetic Propeller or Magnetic Shafts, it is a wheel that is mainly responsible for generating energy due to continuous spinning or endless revolutions when attached to other motorized components and equipment.

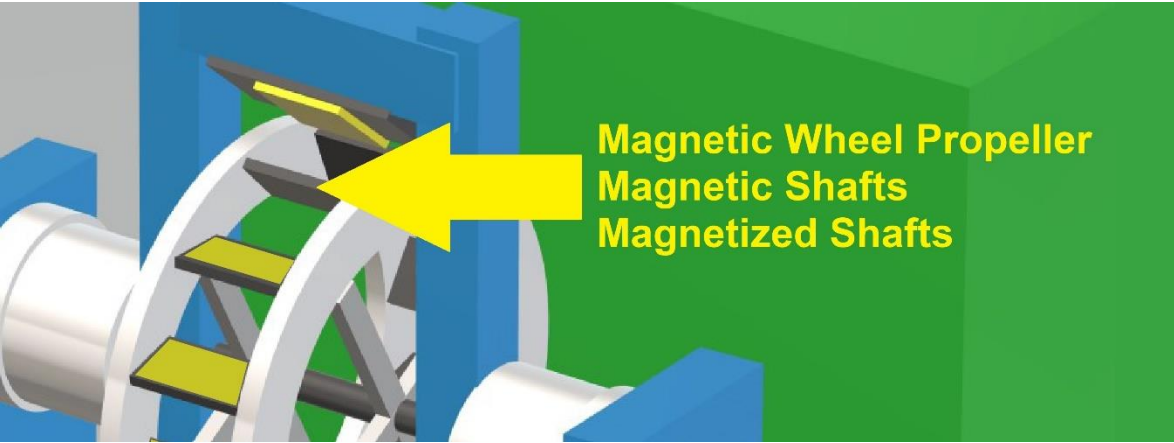

20.1 Magnetic Wheel Propeller, Magnetic Shafts

Magnetic Wheel propellers or magnetized shafts are mechanical components that have flat magnetic plates engraved for creating a complete repulsion and are fitted inside the Free Energy Wheel.

The Magnetic Shafts will have one side exposed Magnetic Blades engraved which will have the same Magnetic charge as the Magnetic Looper to create a repulsion action.

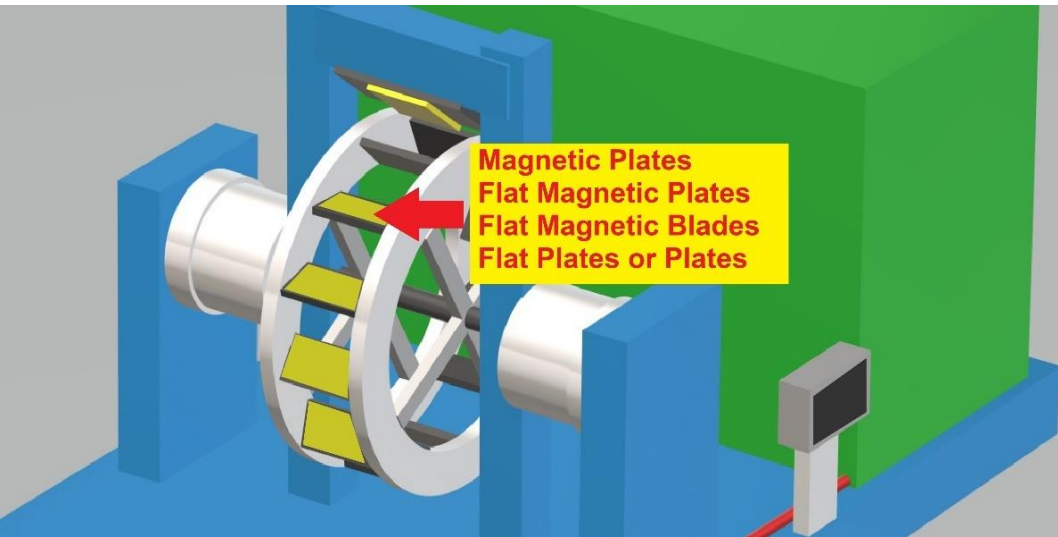

20.2 Magnetic Plates, or Flat Magnetic Plates or Flat Plates or Flat Blades

Magnetic Plates, or Flat Magnetic Plates or Flat Plates or Flat Blades are magnetized mechanical components, that are engraved inside the Magnetic Wheel Propeller, Magnetic Shafts.

The Magnetic Plates or Blades will have one exposed side with a similar magnetic charge as the exposed side of the Magnetic Loopers to create a repulsion.

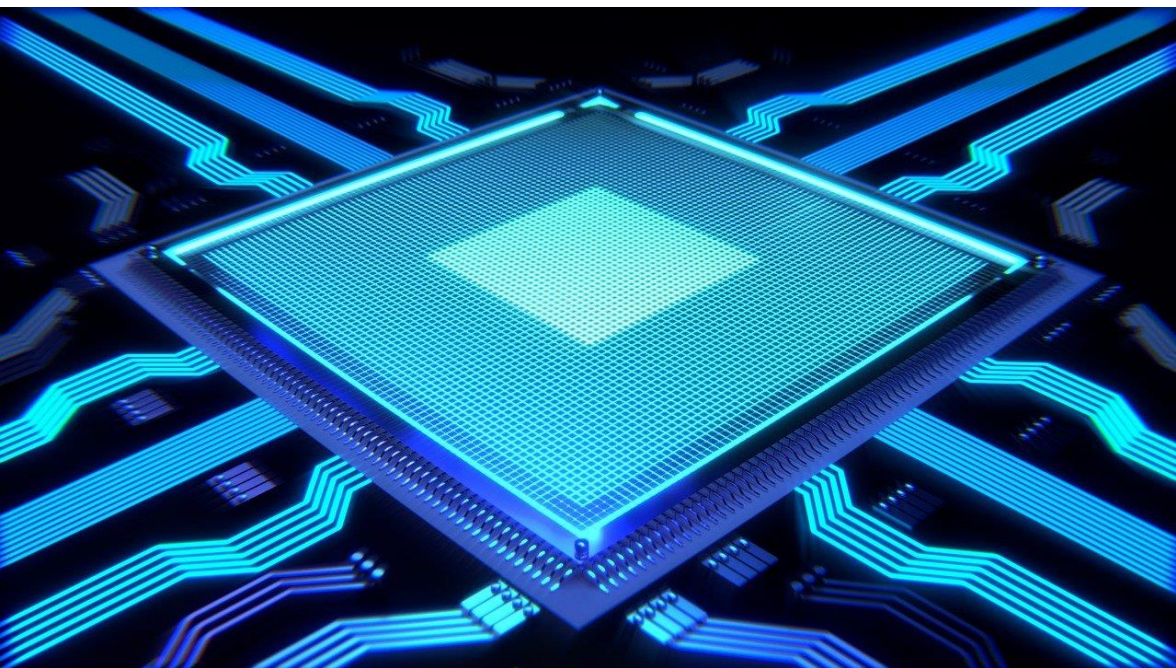

20.3 Central Processing Unit (CPU)

The Central Processing Unit will be the main technological component that will process all the instructions given to the machine, like start, stop, pause, reset, etc. The CPU will be the part of Free Energy Computer System, like any other CPU-Unit that is inside a computer and on the motherboard.

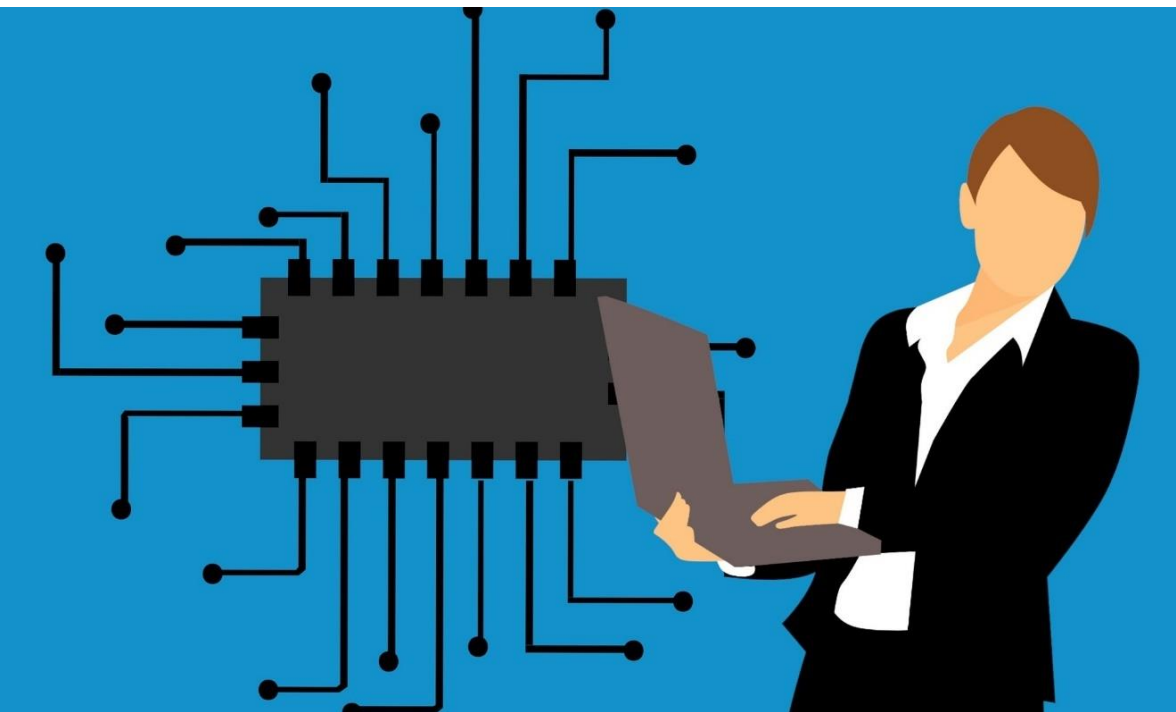

20.4 CPU Functions

The CPU planted on the Free Energy Computer System will be no other than any traditional Processor when it comes to functioning, However, if the companies like Intel and Apple collaborate together, to produce the Next-Generation Processors for The Free Energy Technologies, then it will be really beneficial for the future of Free Energy Technology.

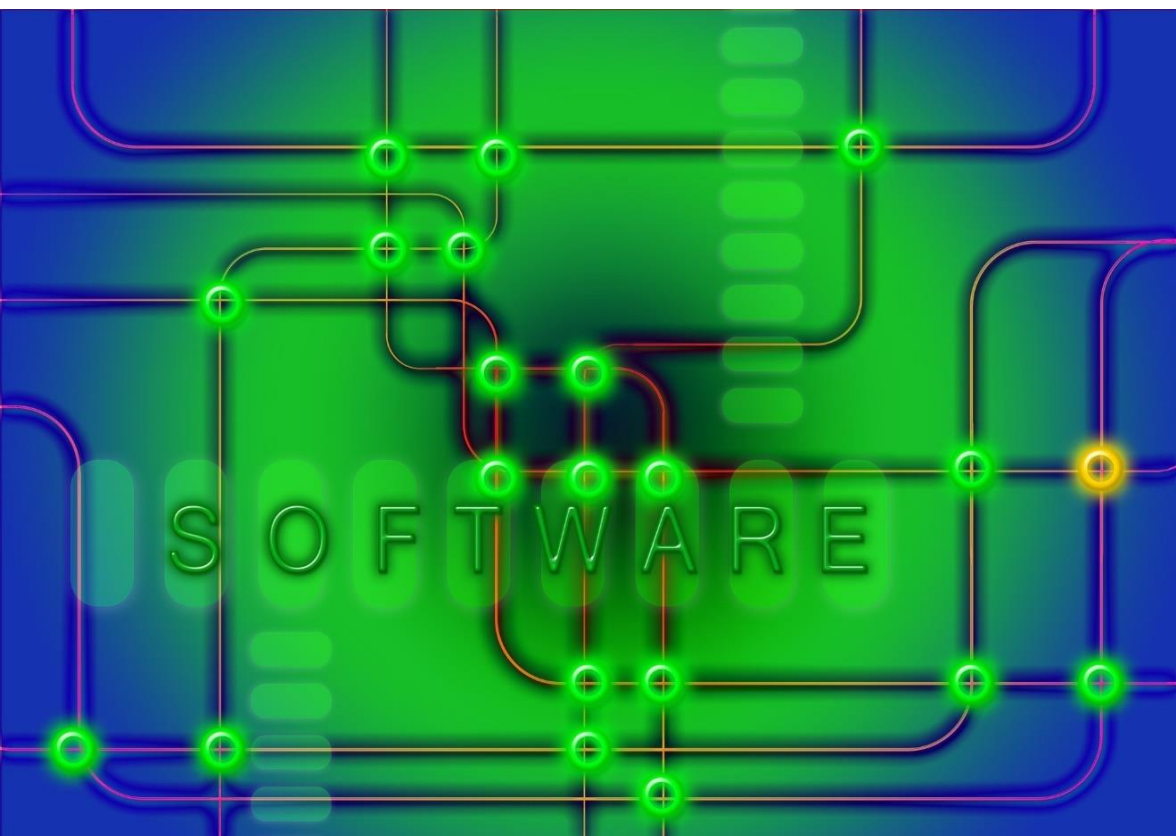

20.5 Software Management

The Free Energy Technology will have a dedicated software application and firmware, or Operating System build, the primary purpose of this software application will be, the management of Free Energy Technology, and controlling of outcomes resulting from this technology. This type of software is essential for making the Free

Energy Technology reliable and for making it perform in the desired way, Some of the Features of Free Energy Software will be, Operation Control Management, Breaking Systems, Boot Operation, Safety Stop Options, Emergency Stop, Maintenance Mode.

This is worth noting that in the future, every product and service, that will rely on Free Energy Technologies, will have a customized version of Free Energy Firmware, Software, and Operating System.



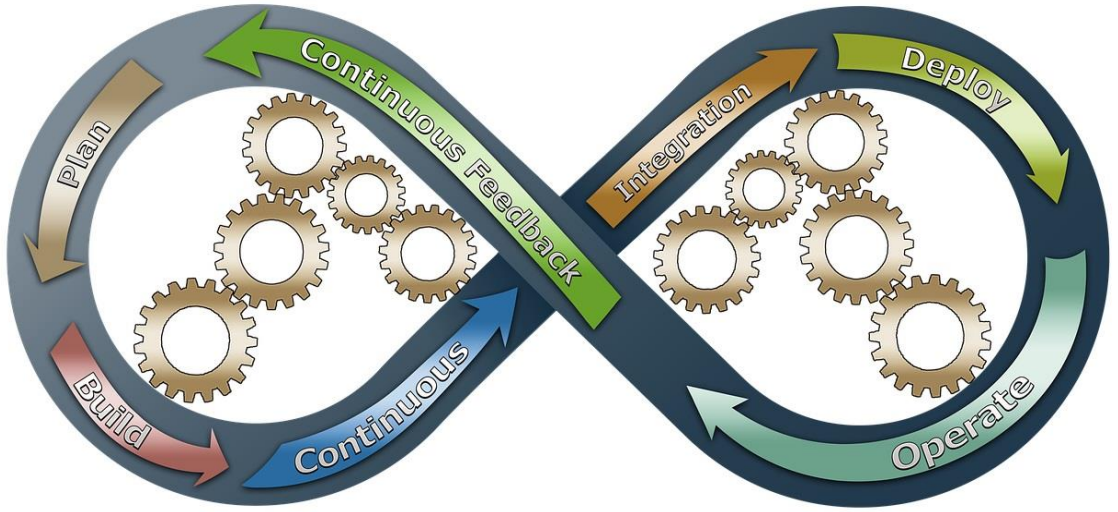

20.6 Software Features

The Free Energy Technology will have dedicated software support, it will not be limited to the functions mentioned in this book, however, innovation is an ever-evolving thing, and the software side of Free Energy Technology will be improved, updated, upgraded, and enhanced overtime with the ongoing developments in the Technology itself.



20.7 Operation Control Management

Free Energy Technology will be based on smarter concepts, and every product that utilizes the Free Energy Technology will have its own operation and control management solutions, built for the Free Energy Technologies.

STOP



20.8 Brake Systems

Free Energy Technology will be based on a concept of an endless loop or continuous motions, however sometimes breaking the operations of Free Energy Engine will be required for a variety of reasons, like Maintenance, Upgradation, Emergency Stop, or else anything that will require the

Free Energy Systems and Technologies to Stop like Overheating, and Fire Dangers.

The Breaking System will be made smarter, the Free Energy Engine will stop dynamically, and safely without causing any troubles, it will be made in such a way that the essential parts and components of the whole machinery stay intact without damages, for example when the endless motion will start due to Magnetic Loopers, the best way to stop the motion will be dispositioning each of the Magnetic Loopers, from their placement, so basically the lever Arm, that enables the Magnetic Looper will be disabled for stopping the Free Energy Engine.



20.9 Pause Operations

The Breaking System will have different functions, like Pausing the Operations, and resuming back with same configurations, and Breaking the Operations Completely for a given time period, and there will be options to schedule start, pause, and stop.



21.0 Schedule Start, Pause, and Stop

The Free Energy Technology will have smart system management, for example, the operator will be able to schedule the start, pause, and stop operation, from the device management settings, in-fact there will be master control given to the owners, for better management of technology, which will enable handling operations smartly, remotely, and exclusively as the master admin.



21.1 Smart Break Operation

The Breaking Options will be governed by smart systematic technology, there will be various types of Sensors, that will detect unusual activity or unwanted performance, or unstable conditions of the Free Energy Technologies, like Overheating, Fire Breakage, Broken Parts, Technical Errors,

and it will have special motion detection Sensors, made to avoid Natural Disasters, like the Earthquakes, by detecting ground vibrations, and elevations, and speed, the Smart Breaking System will stop the Free Energy Technology, and Shut operation temporarily or permanently, according to the given instructions, configurations, and settings.

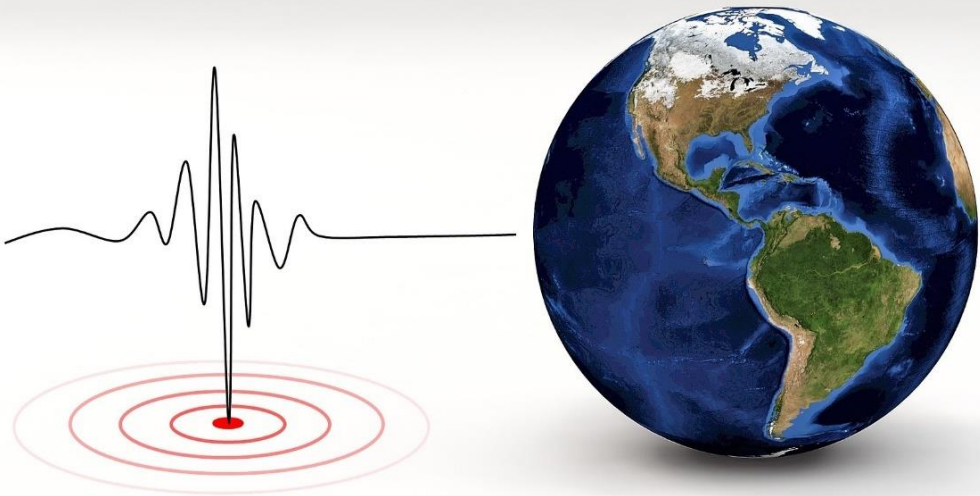



21.2 Safety Stop Options

The Smart Breaking System will also have Safety Stop Options, for example, assume if, some object gets stuck inside the Machinery, then the operations will break and Engine will Stop, in-fact there will be sound detection system built-in as well, for example, if some human-hand gets stuck or else He/She or the machine operator screams at that time, then all the operations, will break and stop, the machine will be made safer for the

environment, and people to operate and run, and building a secure and safe Free Energy Technology is an essential thing, the sound detection system will also have speech detection capabilities, for example, if the owners wish to give verbal commands then the Free Energy Technology will recognize those commands, and work as instructed and demanded by the owner.





21.3 Emergency Stop

There will be Emergency Stop Capabilities in the Free Energy Technology, as Safety Stop and Smart Breaking is an essential function, one of the primary reasons for placing Emergency Stop will be to avoid the dangers and issues related to non-stop operations, we all know that every machine

breaks and requires essential maintenance, at some point during Machine Lifetime, so there are some important issues related to wear and tear, and constant usage and running of Free Energy machine, like Overheating, Fire and Burn Dangers, Breaking of Mechanical Parts, or Burning of Electronic Parts and Components, and due to the mentioned reasons, special sensors and detectors will be made to prevent the fatalities and disasters, however it is worth to note that some Free Energy Equipment and Technologies will be made way bigger to support large projects like Powerplants, Marine-ships, Aircrafts, and others will be smaller like, Computers, Smartphones, Televisions, and Cars, Bikes, and Bicycles, thus every size will have its own special requirements, and pros and cons associated.



21.4 Emergency Start

Like the Emergency Stop, the Emergency Start will be a very handy feature, for example, we can assume different scenarios where the Emergency start can play a vital role, like turning on emergency power, when load-shedding prevails, or when the primary power fuel of an Aircraft

ends, or when a Smart-device lost its charge, so there can be a variety of cases where an Emergency start feature can come in handy.

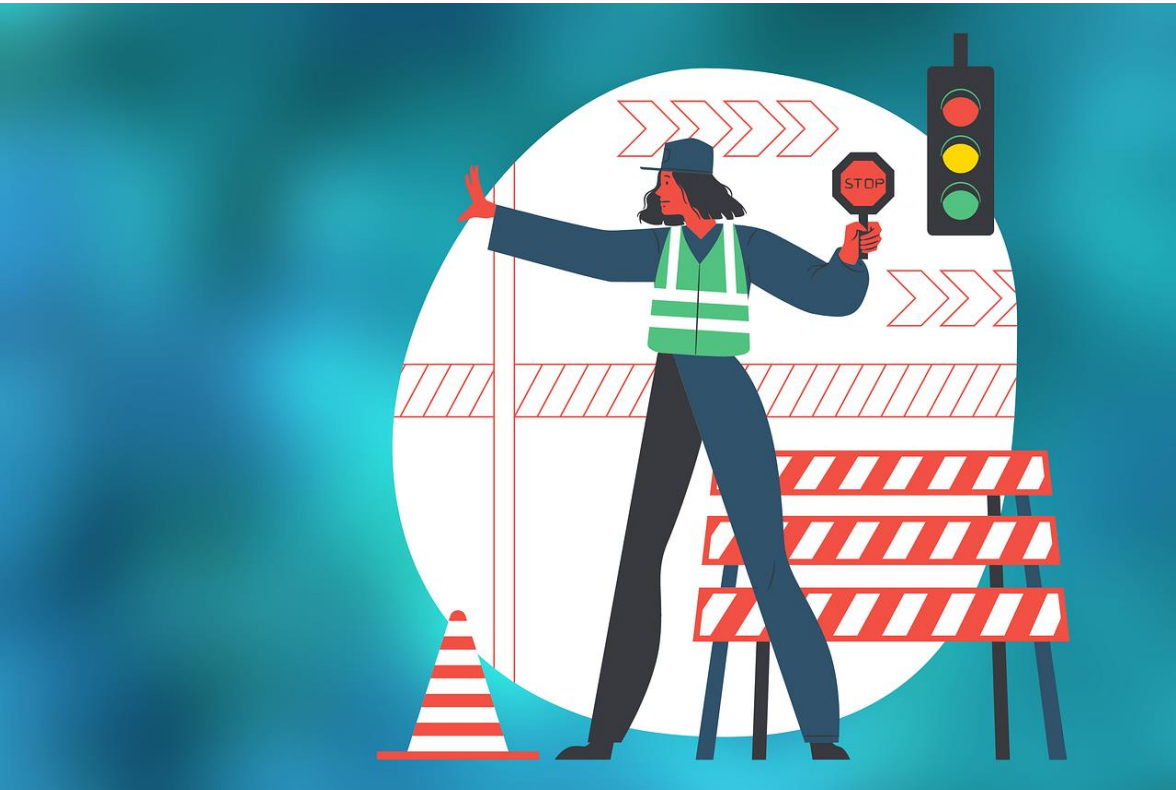



21.5 Maintenance Mode

The Free Energy Technology will have smart Maintenance Modes, and there will be different types of functions available, like maintenance modes for Repairs, and Disassembling or Assembling of Machinery. There will be an internal Log System, that will record what type of Maintenance works has been performed previously, and it will give future engineers important insights

and will provide them with crucial system reports and data.



21.6 Disassembling Machinery

The Free Energy Techs will come in different sizes, and the entire machinery will be made in such a way that, the Disassembling or Assembling process will be very easy to manage, and everyone will be able to understand the basics, and the

advanced techniques required to perform a variety of Maintenance Works.



21.7 Assembling Machinery

In the future people will be able to setup, customize and upgrade Free Energy Technology, like building a computer system, or playing with Lego set or kids blocks, there will be next generation toolkits, provided for performing different

types of customizations and upgrade works, the Free Energy Techs will come in different sizes, and boxes, and assembling Free Energy Equipment will be very easy, fast and seamless.

Booting...

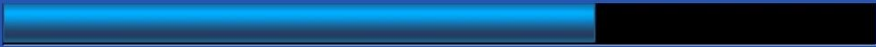

21.8 Boot Operations

There will be a variety of Boot Options available and programmable for configuring the Free Energy Machine, such as the Safe Boot, Advance Boot, and Basic Boot. The Safe Boot will run essential configuration for performing technical tasks safely, while the Advance Boot will be used to perform advanced configuration, and the basic will

be used to perform basic operations.



21.9 The Research

Building a Free Source of Energy Technology requires great research work, and because the primary concept requires an advanced understanding of physics, the innovators need to have some knowledge about the basics of motion sciences.

The Engineers that will work on Free Energy Projects, may need to know the basics of mechanical, theoretical, and scientific aspects of the Free Energy

Concepts and Technology.

For developing an advanced Free Energy Technology, a deeper understanding is required in the areas of sciences like mechanical, theoretical, physics, mathematics, and electronics.

In the Future the Free Energy Technology will become a very common thing, and not only Adults, but kids will play with toys, based on Free Energy Technologies, these types of toys will teach the kids the importance of such initiatives, and make them capable of developing and managing the Free Energy Technology in the future.

CONSUMER STORAGE
COMPUTERS MARKETING SAMPLE
BYTES **BIG DATA** RESEARCH
BEHAVIOR ANALYTICS TECHNOLOGY
INFORMATION SIZE INTERNET

22.0 Gathering Information

For Building the Free Energy Technology, sufficient research is needed to understand the essentials of Free Energy Techs, for example, a deeper study is required in the field of Physics related to the understanding of motion.

Free Energy Technology is based on building a machine, that can generate Free Electricity, due to the endless loop of

mechanical motion in form of a Free Energy Engine, thus it is required to take a deeper look into the concepts of Endless Mechanical Motion.

Data Collection based on motion sciences, and physics is required for finalizing, and deep understanding, the concepts of an endless loop of mechanical motion.

Various types of case studies are required for fully understanding, and further proving the Free Energy Concept, based on Endless Loop of Mechanical Motion, However, there has never been researching done on the subject but, finding and creating scenarios based on endless mechanical motion can be done easily, as scientist and innovators around the world can create different simulations, where they can prove theoretically and practically, that such technology can exist based on various models and scientific projections.



22.1 Progressing to the Development Stage

The Development stage of Building Free Source of Energy Technology has a variety of important tasks, and systematic planning is required.



22.2 Team Building

Team building is an essential part of the success of Free Source of Energy Technology, the first step is to hire the right motivated people, and recruiting engineers, that closely relate to the field, with the required expertise in the subject matter is essential path towards project success.

Some of the Qualities that the Free Energy Team needs to have are, Like Mindedness, and drive to work for the same cause, and same goals on a daily basis. The focus of the entire team needs to be diverted towards achieving the same objectives of Turning the Free Energy Technologies into a reality.

It is very crucial to hire people, that have the right background and understanding in the fields, that are required to build the Free Source of Energy Technologies.

The Free Energy Team will have, a group of Physicist, Chemist, Electromechanical-Engineers, Mechanical-Engineers, 2D and 3D Drafters and Designers, 2D and 3D modelers, Mechanical Drafters and Designers, and Scientific Research Team. The Primary reasons why a team of a chemist is also required is because, the Energy Storage Power-banks has certain chemical components that enable the capacitating and storing of Electrical Energy, and a special team of chemist

might be required to work on the subject matter, however, such Power Storage Banks can be built via third-parties, that specializes in such technologies, and those that have dedicated and talented teams.



22.3 The Development

Developing Free Energy Technology can be a very difficult task, for those who are trying to build the first time, however, if you

grasp the main ideology, concepts, and research, and have expertise and passion for innovative technologies, then the task may seem easier than you think.



22.4 The Mechanics

The mechanics behind the working of Free Energy Engine and Technology are simple, but making the whole idea work may be a hefty task, in order to enable Free

Technology to work, systematic planning and mechanical precision are required.

The mechanical component inside the machine needs to be aligned in such a manner, that makes the whole machinery work with desired results, and for achieving precision perfection, a team of master artisans is needed in the electromechanical field.

Free Energy Engine's Mechanical Parts needs to be shaped, molded, and made perfect in order to make the machine work, however in order to make the idea work, one needs to create a set of mechanical parts for experimenting, you cannot aspect one design to perfectly work according to plan, however, multiple tries will draw a better picture, for perfecting and figuring the workable design.



22.5 The Engineering

Conceptualizing and drawing a workable Free Energy Technology is simple but implementing it into a reality is a bit complicated, and because not every plan will work and failures are an essential teacher, thus a team of Engineers who are specialized in the mechanical designs or

electromechanical field or scientists with expertise in mechanical system and technologies and physicist, are an essential requirement.



22.6 Modelling the Prototype

Modeling a workable prototype requires detailed research work, the creation of various simulations is needed, in order to

better understand the concepts, the engineers and 3D modelers need to work closely for creating different scenarios concerning the Free Energy Technology.

The backbone of Science and Technology is experimenting, thus various types of ideas need to be tested for figuring out the micro details concerning the main idea, somethings might be changed and new things, will be added to the primary concept, on a daily basis for building the first prototype, and learning from each prototype examples, will lead the research team, to better understand the right ideas, and the workable prototype will be the result of past failures and experiments.



22.7 Resourcing

Building a Free Source of Energy requires plenty of resources, thus acquiring the right resources is needed for every stage of development, for example, to create each component, different types of materials are needed like, the motorized parts, the adjusters, loopers, or any other that supports the Free Energy Machines.

With time, Free Energy Technologies will become a very common phenomenon, thus revolutionizing research and advancements will be done in this particular subject matter and space.

What materials are the best to use, and which resources are essential will be decided in the later and advance stages of development, the first stages will only prove the concept valid and possible, while the real advancements, will be made when people will start accepting, believing and considering the concepts of Free Energy Technology.

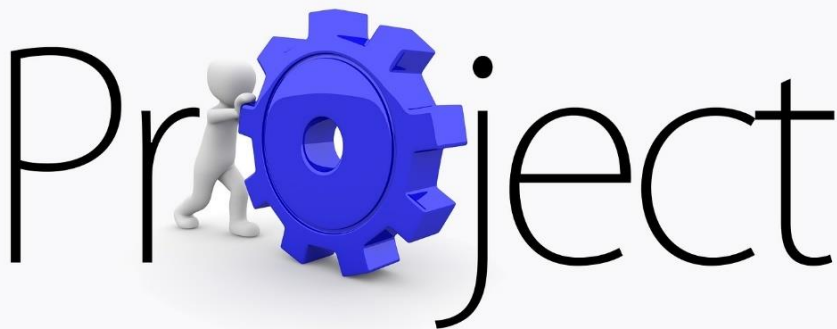



22.8 The Project Structure

Understanding and creating the right project structure is an essential requirement, for the Free Energy Projects, there are various steps which are needed to be sorted out ahead of time, to better the project plan, and for greater results, with higher accuracy of expectations matching the reality with fewer errors.



idea → *plan* → *action*

22.9 The Plan and Execution

Creating a road map of Free Energy project is an essential requirement, thus making a simple and realistic plan is needed, one of the best way is to create a segmented master plan or stages of project, for example the first stages will be to conceptualize the working idea, for that the research team is needed to figure out various concepts, second stages can be of figuring out how to acquire the right resources to implement the chosen idea, and for that different team of project administrators and experts in logistics are needed, and third will be to create the

required mechanical components and for that a team of engineers in the electromechanical fields are needed, and by creating different segments and delegating the job to the right team, the efficiency can be increased, thus a systematic approach is needed, However here we are only discussing the importance of creating project stages, but the real process will be very different, depending on the types of team, and project managements.





23.0 Experimenting

Experimenting is the most essential aspect of every innovation, thus for building the Free Source of Energy Technology, many experiments need to be conducted, for example, various concerns need to be addressed like, how the mechanical components will behave, and how much magnetic power is needed for the exertion

of sufficient force, and what kind of machine components are needed, estimating the revelations and power generation, validating the concepts, so basically, the Free Energy Concepts, needs to be tested and detailed experimentation is required.





23.1 Possible implications

There will be many implications when the Project is going on, some of the common issues can be, insufficient research, as many times the research teams may not cooperate with each other, or else they will lack common understanding.

insufficient resources can be another possible implication, as some required

components may seem very hard and costly to acquire, and without proper materials, the Free Energy Technology Projects will face difficulties.

Lack of skilled workers, as building the Free Source of Energy Technology requires a team of well-trained and experienced professionals, from various disciplines, so team building and human capital can be another major issue.

Fundraising and financial freedom can be another major implication and a primary hurdle, that can negatively affect the success rate, as many investors might not properly understand the concept, and lack of communication can occur, however, there are many organizations that are willing to support the cause of protecting the planet from various disasters.

Ending up with failures is the most common implication, that every innovator faces, thus one needs to expect a lot of failures on the road, as the famous Thomas Edison quote,

I have not failed, but I have found 10000 ways that won't work.



RESULTS
~~EXCUSES~~

23.2 Expectations

Meeting the expectation can be a very hefty task, as most of the time people lack the required knowledge, and an inexperienced engineer may not be able to come up with the working concept very early, however, we have heard that the practice makes the man perfect, as no one will be great at the start but after a while of keeping with struggle, people ultimately improves, thus

for meeting the expectation of turning the Free Source of Energy Technology into a reality, a lot of patience, practice and practicality, experimenting and theoretical time is required.

~~failure~~

success



A woman in a grey pinstriped suit and white shirt is holding a white banner. The banner features the text "QUALITY CONTROL" in large, bold, black capital letters. A red circular logo with the words "CONTROL" and "QUALITY" is positioned over the letter "C" in "CONTROL".

QUALITY CONTROL

23.3 Improvements

The improvements along the way will become an ordinary thing, as there has never been a project like the Free Energy Technology, thus every new concept, needs to be tested and validated, and addition of newer concepts and accepting the latest trends is the part of the job, as the scientific advancements keep progressing,

the Free Energy Technology will seem very different, 10 decades from now because every concept and technology is upgraded by time, hence what we build today will become obsolete few centuries from now.

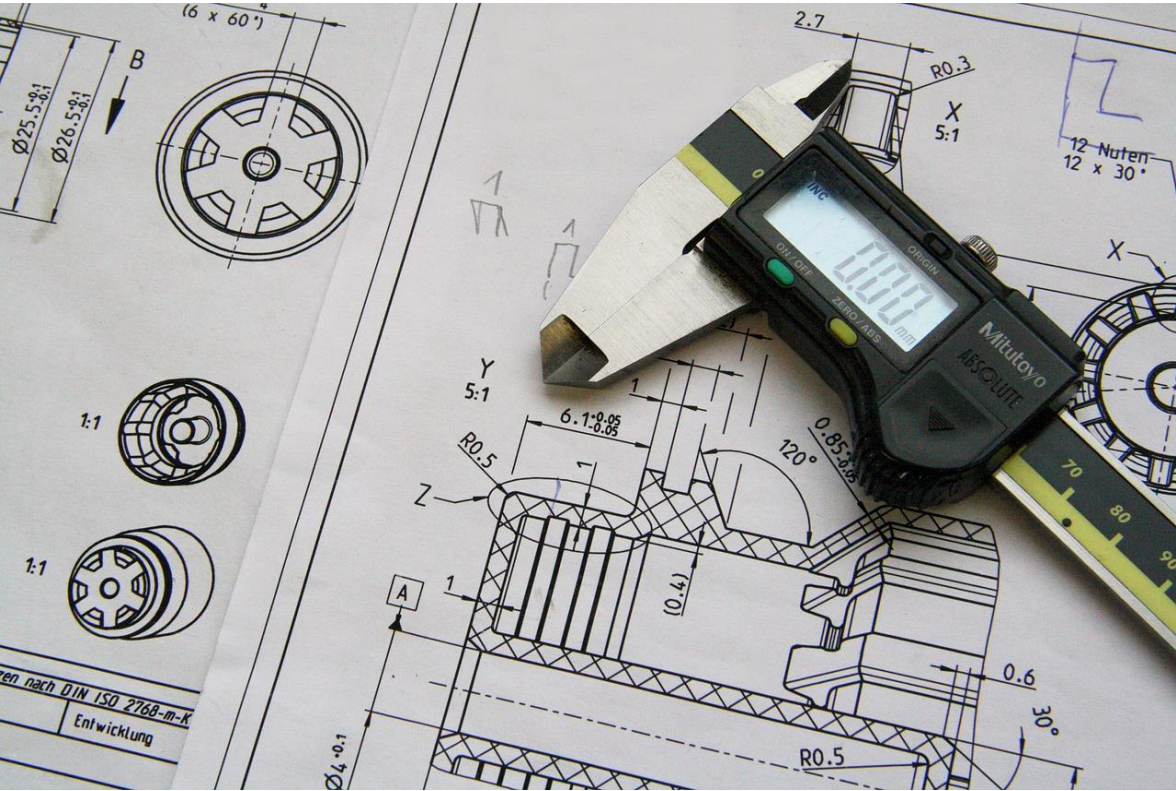

23.4 Improving the Designs

Free Energy Technology's Design improvements, will become a very common thing worldwide, there will millions of

products and services and everyone will have their own customized design, imagine a Free Source of Energy Technology Component, inside a smartphone will seem very different from the ones used in the Air-Conditioner or a futuristic Electric-Car.

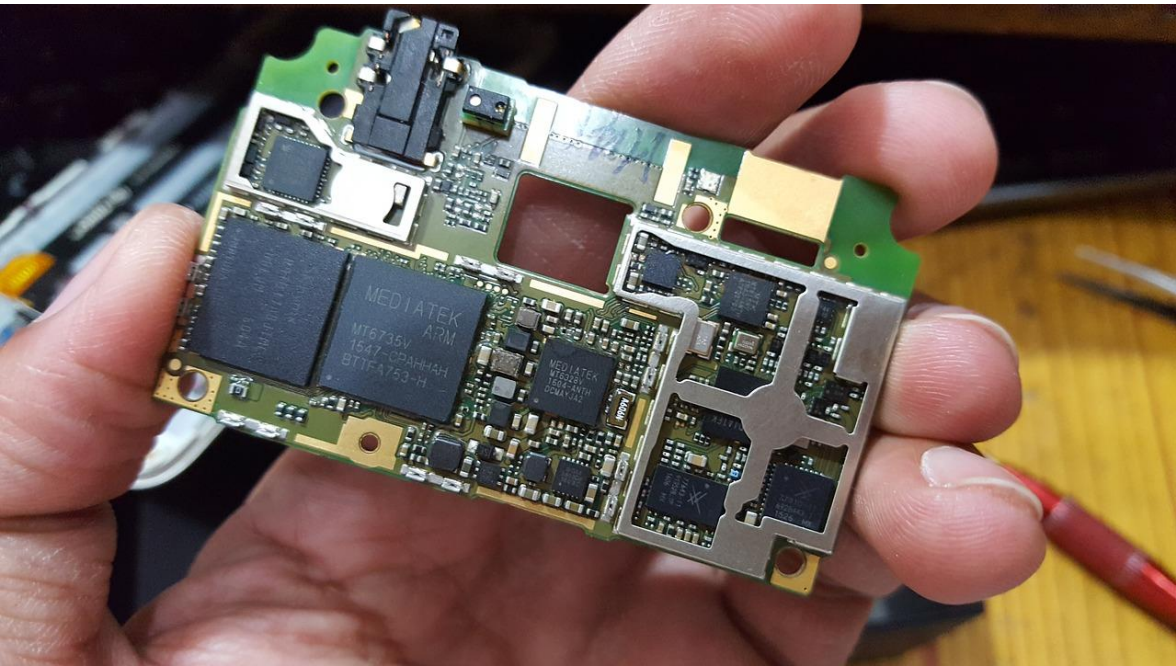



23.5 Improving the Qualities

Improving the overall qualities of Free Source of Energy Technology, will become a common norm amongst the innovators and industry leaders, for example, the companies will be concerned to develop, those Free Energy Techs that can generate more electric power in a shorter time, and with more durability in terms of energy

storage, and longer product lifetime, another desirable feature will be smart connectivity, a personalized mobile application, and a wireless remote control or smart device application that can control everything from a distance, For example, an air conditioner attached to Free Source of Energy System and Technology will be controlled wirelessly, and the consumers will be able to turn off or on the device remotely.





GOAL * PLAN * SUCCESS

23.6 Goals and Milestones

A Free Energy Technology Company will have many goals, like any other innovative company in the world, and to accomplish the big vision, many smaller milestones need to be met, reaching the ultimate goal of turning Free Energy Technology into reality can be a very challenging task, and for building a revolutionary product requires a solid commitment to the core mission, and that is of changing and revolutionizing the world, and saving the planet from devastating events, such as climate change, oil, and energy crisis, oxygen depletion, and preventing air pollution-related casualties globally.



23.7 Reaching Goals

One of the most important goals for the Free Energy Projects will be to Advance Research and Development in the subject matter, as discussed earlier, a Free Energy Platform can drastically speed up the process of innovation, due to millions of brains working for a similar cause, thus building such platform for the world, will prove to be a very impactful step that can lead to immense success.



23.8 Improving Standards

A Free Energy Platform can play a crucial role in improving the overall standard of Free Energy Technologies, as we have heard that two brains are better than one, so as millions of brains are essential for building the worlds most revolutionary technology, that will shape the future and give new hope to future generations, and those that are already suffering from power crisis.



23.9 Project Building Stages

A typical Free Energy Project will have many phases, like recruiting the best talent, conceptualizing master plans, Building Research and Development department, Allocating Resources such as Financial, and administrating the acquisition of required materials, liaising with external and internal teams, Seeking Investors and

creating Fundraise campaigns, and handling of Media Campaigns for publicity.

The fun part of the Free Energy Project will be the experimenting and testing phases, and prototyping, because that stage will be very critical for success, as it will be one of the final phases towards completion of the final working prototype, Another interesting phase will be of Prototype Crafting and modeling, as special visual designers will be creating 3D-Graphics, and various types of 3D-Simulations will be made prior to the crafting of an actual prototype, this type of phase will be mostly liked by the so-called computer nerds.

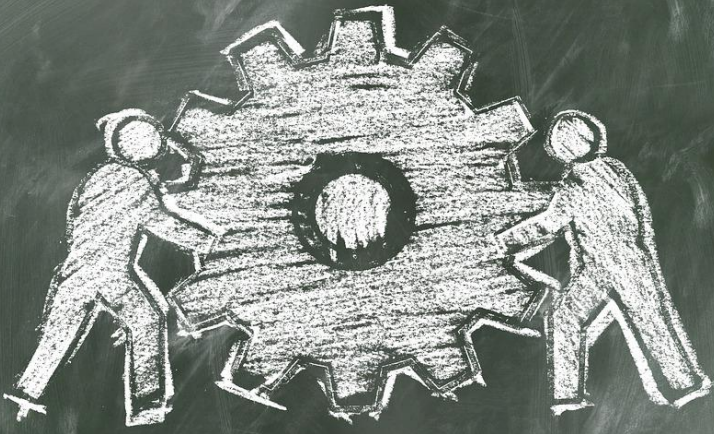

24.0 Project Deployment Stage

The stage when the prototype will be finally released and deployed for further consideration will be the Project Deployment Stage, in this stage, the simulated models will come to reality, with the desired outcomes.



24.1 Project Finishing Stage

Project Finishing Stage will be The Final Stage where the prototype will be evaluated and matched against the expectation vs reality, various quality checks will be performed to determine the flaws and functionality, and machine health.



24.2 The Final Results

The Final Results will be comprised in the reports concerning the project success based on performance, experimenting, and testing, and identified failures, the final reports will determine the future of the project, and if things go according to the plan, then a new milestone will be reached in the history of science and technology, otherwise building a new improved prototype will be considered.



24.3 Reaching the Milestone

Building the First Prototype will only mean, that there is a light under the tunnel, as it will give tremendous hope to the project team, and the world and First prototype will prove the Free Energy theory a valid concept, thus it will be the first step towards building a more sustainable, reliable, fully functional and operational Free Source of Energy Technology, that will revolutionize the world.



24.4 Media Support

After a working prototype is released, the project owners can pitch and take their success story to the global media, and by gaining the world's attention, after reaching the first milestone will prove to be a very wise decision, especially for attracting new investors, and for seeking support from industry giants that can help the Free Energy Concept and Technologies to thrive, and make them grow into a recognizable cause.



24.5 Renovating the Existing Product

After gathering media attention and attracting enough investment, the next step will be to improve the existing product and working on releasing a better version.

A photograph showing the words "PRODUCT REVIEW" spelled out using white tiles with black letters. The tiles are arranged in two rows: "P R O D U C T" on the top row and "R E V I E W" on the bottom row. The background is a light-colored marble surface with grey veining. Several other white tiles are scattered around the main arrangement.

PRODUCT REVIEW

24.6 Feedbacks

The first prototype and the newer releases will gather enough attention from many technologists around the globe, thus very critical reviews and feedbacks will be obtained from the global audiences.



24.7 Collaborations

Due to the success of the first working prototype releases and media coverages, many technology companies and their tech-enthusiast shall be willing to join and collaborate on the future Free Energy Projects.



24.8 Working on the better versions

Collaborating with different types of innovators and tech companies can open the path towards higher success, as building a superior version with enhanced features will require new ideas, so the new teams can bring better concepts that can really support the cause and improve the overall development of Free Energy Technologies.



24.9 Stable Product Development

A stable Product Development requires sufficient resource allocation, thus collaborating with new organizations and teams can lead to resource fulfillment, whether financial, intellectual, or reputational.



25.0 Ready for Public Usage

Once a stable product is developed, it will be measured against the possibility of going public, or public trials, thus valuable insights can be gathered from the general audience. The public interest can really open doors to new opportunities in the Free Energy Field, and many innovative

companies and inventors around the world will be interested in the subject matter, leading towards more diversity in the Free Energy Field, thus a new cycle of revolution, with endless possibilities of new discoveries will be made.



25.1 Identifying the Market Size

The Free Source of Energy Technology will affect almost every industry in the world,

thus many organizations will start identifying the market early, and will consider investing in Free Energy Concepts and Technologies. The Free Energy Technology Market Size will be measured in Trillions of Dollars Globally, thus every industry in any nation around the world will be interested in upgrading their existing products and services, and shall work towards building, developing, transforming, and adapting Free Energy Concepts, Systems and Technologies.



1. Choice
2. Chance
3. Change



25.2 Meeting the requirement

Every industry around the globe will start producing products and services to meet the requirement, and closing the market gaps, and many entrepreneurs around the world will start developing businesses in the Free Energy Sector.



25.3 Closing the market gaps

Different types of Free Energy Products will be produced globally by the technology industries to close the market gaps, and in the future, this industry will face very high competition.



25.4 Working towards the future vision

Realizing the future vision of Building Free Source of Energy Technology, will be a challenging task, and building a Technology that can save the planet from devastating events, and at the same time revolutionizing the global industries is the only shot worth taking, for avoiding the anticipated events, such as the Climate

Change, Oil and Energy Crisis, Oxygen Depletions, Air Pollution or any other related to Global-Warming, and Power Consumption Crisis.



25.5 Opening doors to the new era of modern technology

Building the First Working Prototype will open the doors towards the new era of revolutionizing advancements based on Free Energy Concepts and Technologies, as we have heard that a journey of a thousand miles, begins with one step, thus

the first smaller achievements in the Free Energy Subject-matter and field can prove to be a doorway towards, a global revolution and a savior of the planet earth.



25.6 Free Energy Engines and Machines

Free energy engines and machines prototypes and concepts and mechanical models and illustrations and drawings, copyrighted and licensed work and an intellectual-property of Syed Mohammad Ahmed, the author of this book, please read and accept the intellectual-property and copyrights notices and obtain License and written permissions and consent from the original owner and accept all the terms and conditions before using and applying these concepts.

The following Free Energy Engines and Machines concepts, illustrations, and models are Included in this book for the readers.

1 Looper Engine Free Energy Machine
3 Looper Engine Free Energy Machine
4 Looper Engine Free Energy Machine

2 and 3 Wheels, 1 Looper Engine Free Energy Machines

25.7 - 1 Looper Engine Free Energy Machine

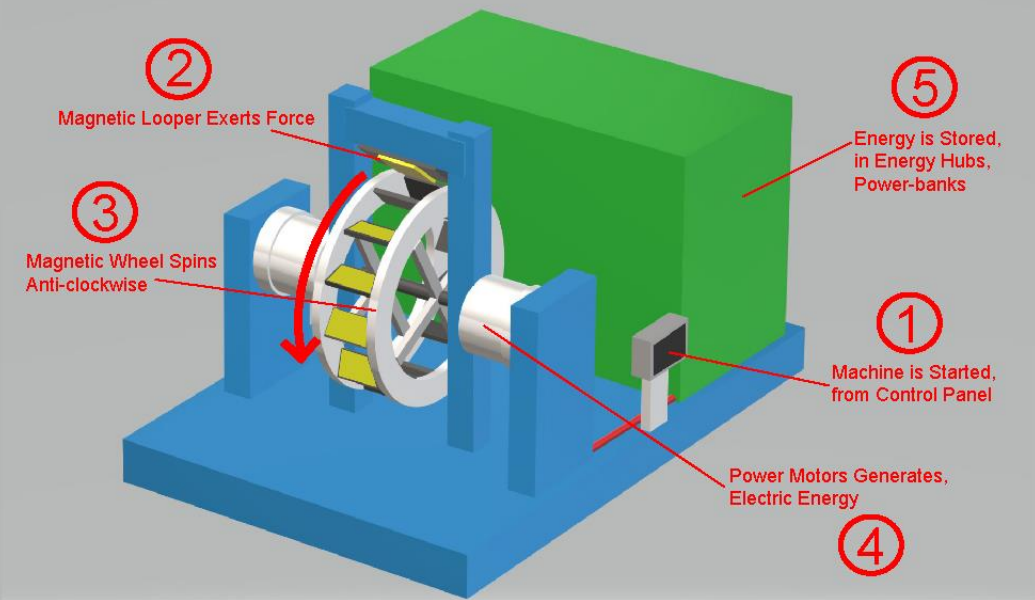
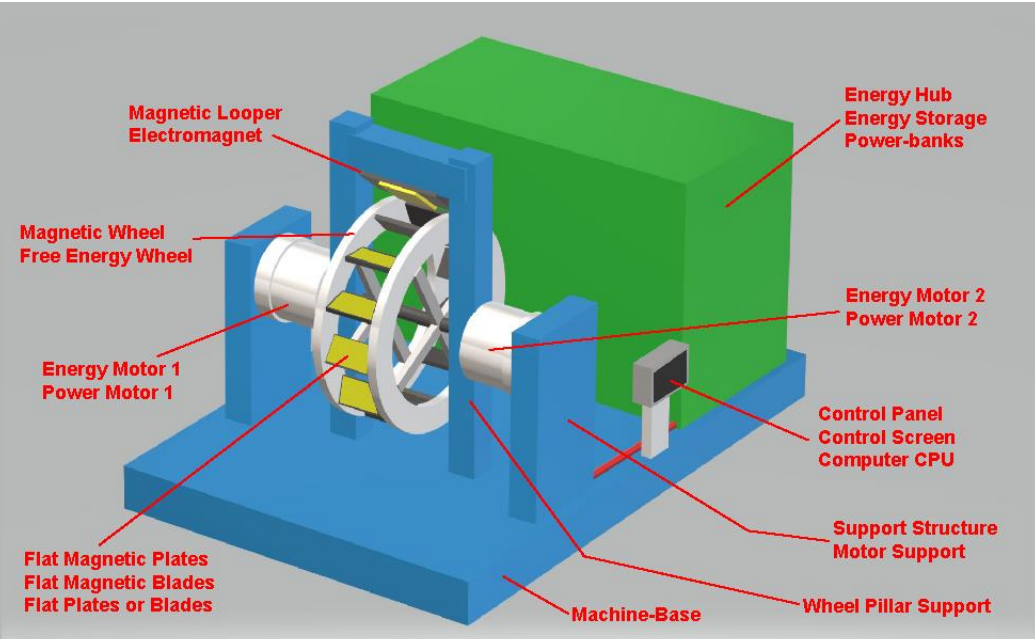

25.8 - 1 Looper Engine Free Energy Machine in-action elaboration

In the first step, the free energy engine and the machine are started from the control panel.

Then the Magnetic Looper or Electromagnet is activated, which starts exerting the magnetic force to the Magnetic Wheel's Magnetic Flat Plates or Blades in a preconfigured and systematic way, and that makes the Magnetic Wheel Spin in an Anti-clockwise direction.

Keep in mind that the Magnetic Looper or Electromagnet will have the same magnetic charge on the exposed side as of the exposed sides of Magnetic Flat Plates or Blades, for creating a magnetic repulsion.

Upon the Spinning of the Magnetic Wheel or Free Energy Wheel, the Power Motors on both sides of the Wheel start generating electric power, because both the motors are attached to the Magnetic Wheel or Free

Energy Wheel.

Finally, the electric power that is generated by the motors is stored in the Power-banks that are inside the Energy Hubs.

The whole process and action keep on repeating until stopped, thus, an infinite and predetermined electric energy is created and stored.

25.9 - 1 Looper Engine Free Energy Machine model pictures.

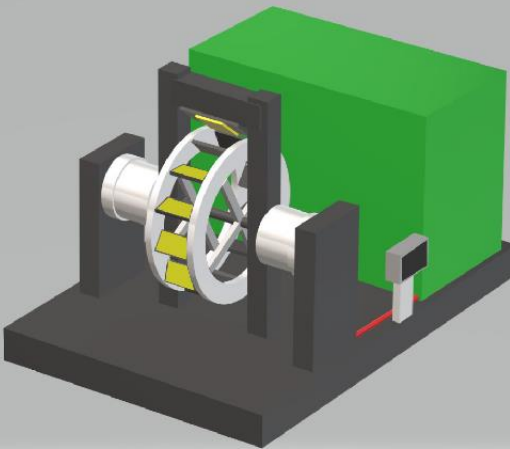
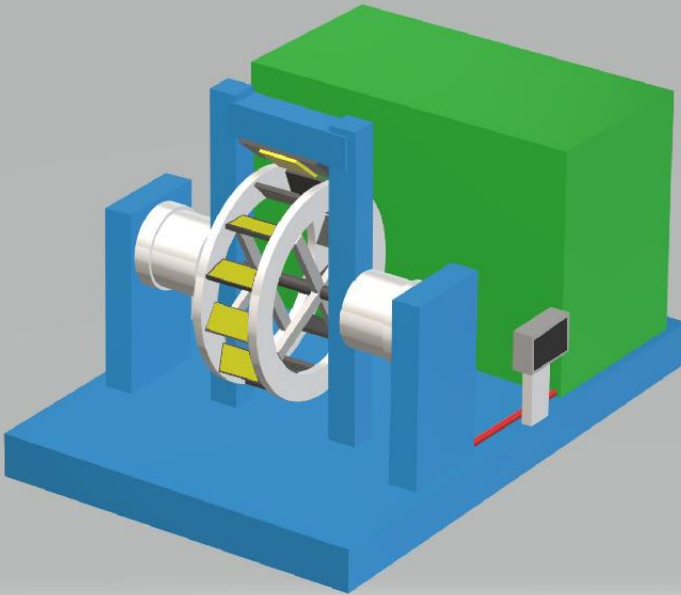

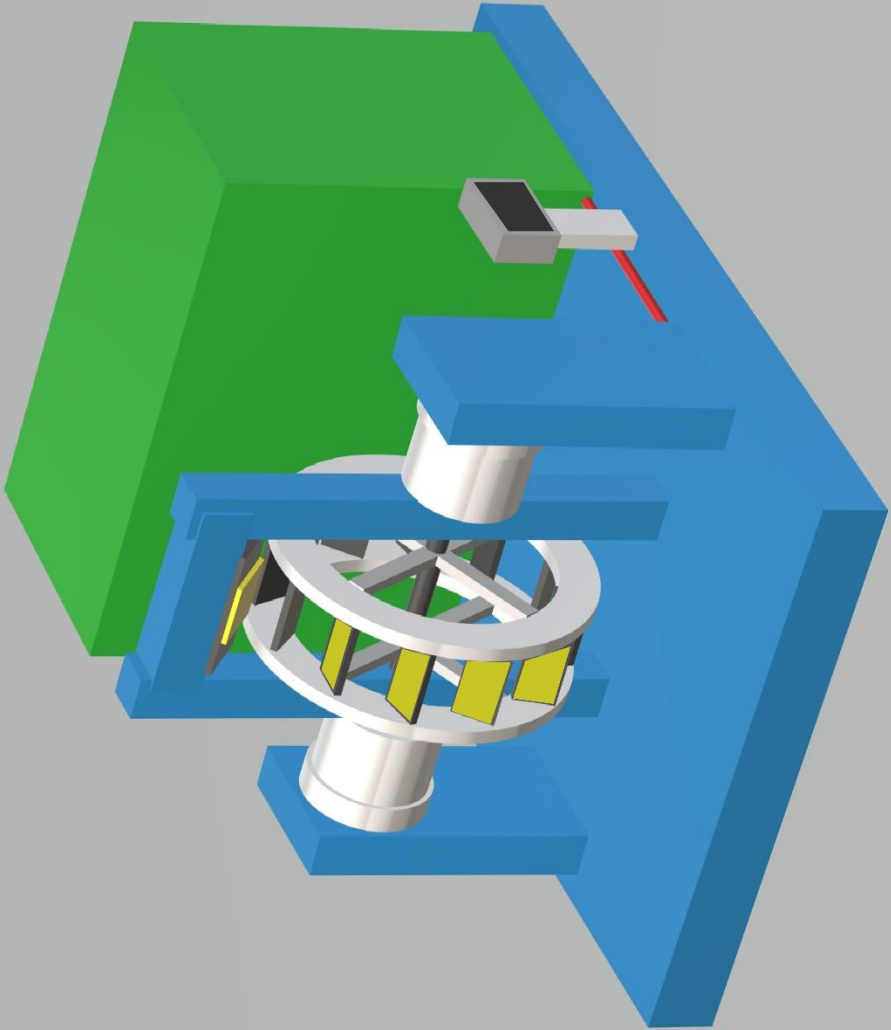

26.0 - 3 Looper Engine Free Energy Machine

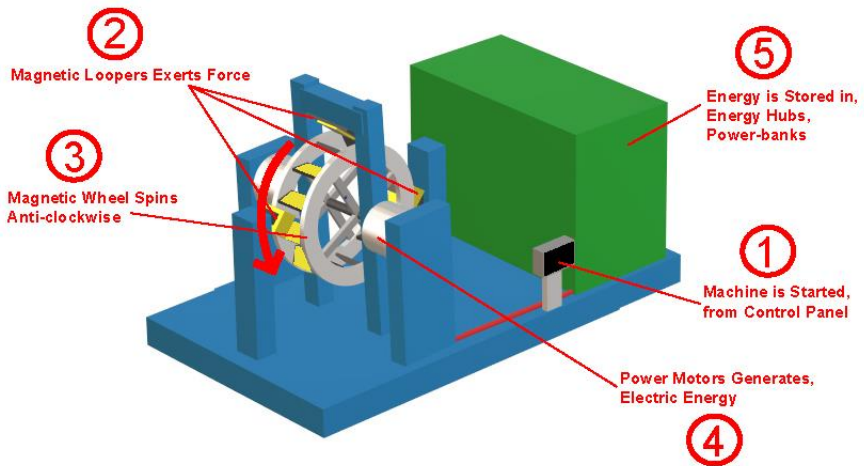
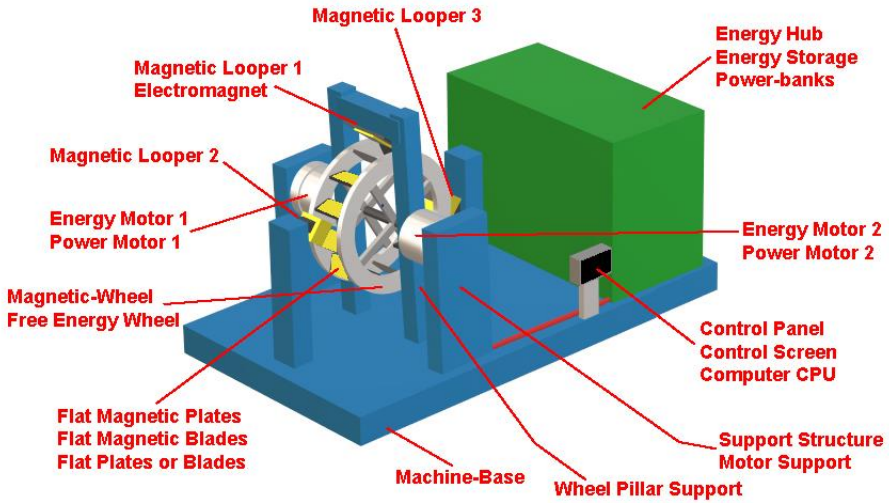

26.1 - 3 Looper Engine Free Energy Machine in-action elaboration

In the first step, the free energy engine and the machine are started from the control panel.

Then all 3 Magnetic Loopers or Electromagnets are activated, which starts exerting the magnetic force to the Magnetic Wheel's Magnetic Flat Plates or Blades in a preconfigured and systematic way, and that makes the Magnetic Wheel Spin in an Anti-clockwise direction.

Keep in mind that the Magnetic Loopers or Electromagnets will have the same magnetic charge on the exposed sides as of the exposed sides of Magnetic Flat Plates or Blades, for creating a magnetic repulsion.

The 3 Magnetic Loopers or Electromagnets can be configured to exert or activate at certain timing with Magnetic Wheel or Free Energy Wheel one by one or else all at

once, they should also be configured in such a manner that if any one of the Magnetic Looper or Electromagnet stops working then the remaining Magnetic Loopers will keep on working smoothly, and the power must cut-off automatically for the non-working Magnetic Loopers.

Upon the Spinning of the Magnetic Wheel or Free Energy Wheel, the Power Motors on both sides of the Wheel start generating electric power, because both the motors are attached to the Magnetic Wheel or Free Energy Wheel.

Finally, the electric power that is generated by the motors is stored in the Power-banks that are inside the Energy Hubs.

The whole process and action keep on repeating until stopped, thus, an infinite and predetermined electric energy is created and stored.

26.2 - 3 Looper Engine Free Energy Machine model pictures.

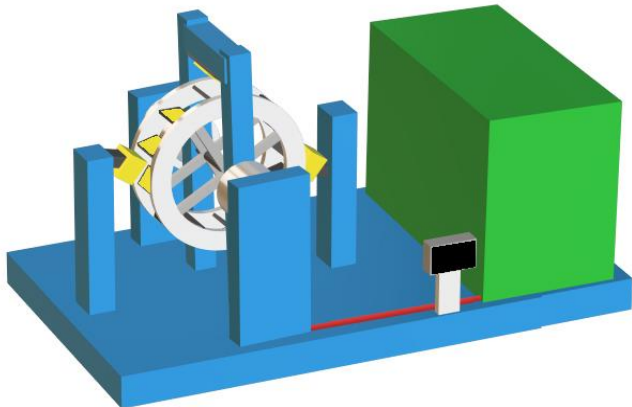
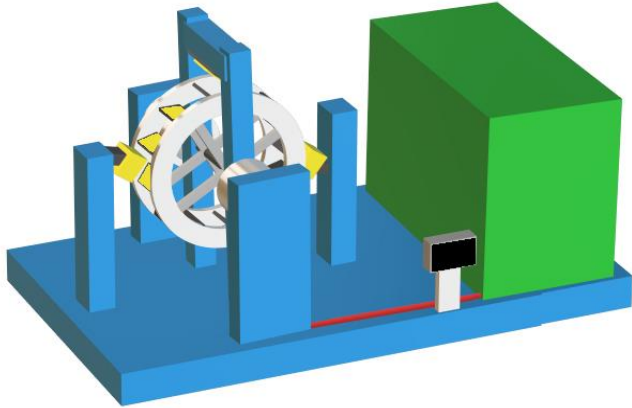

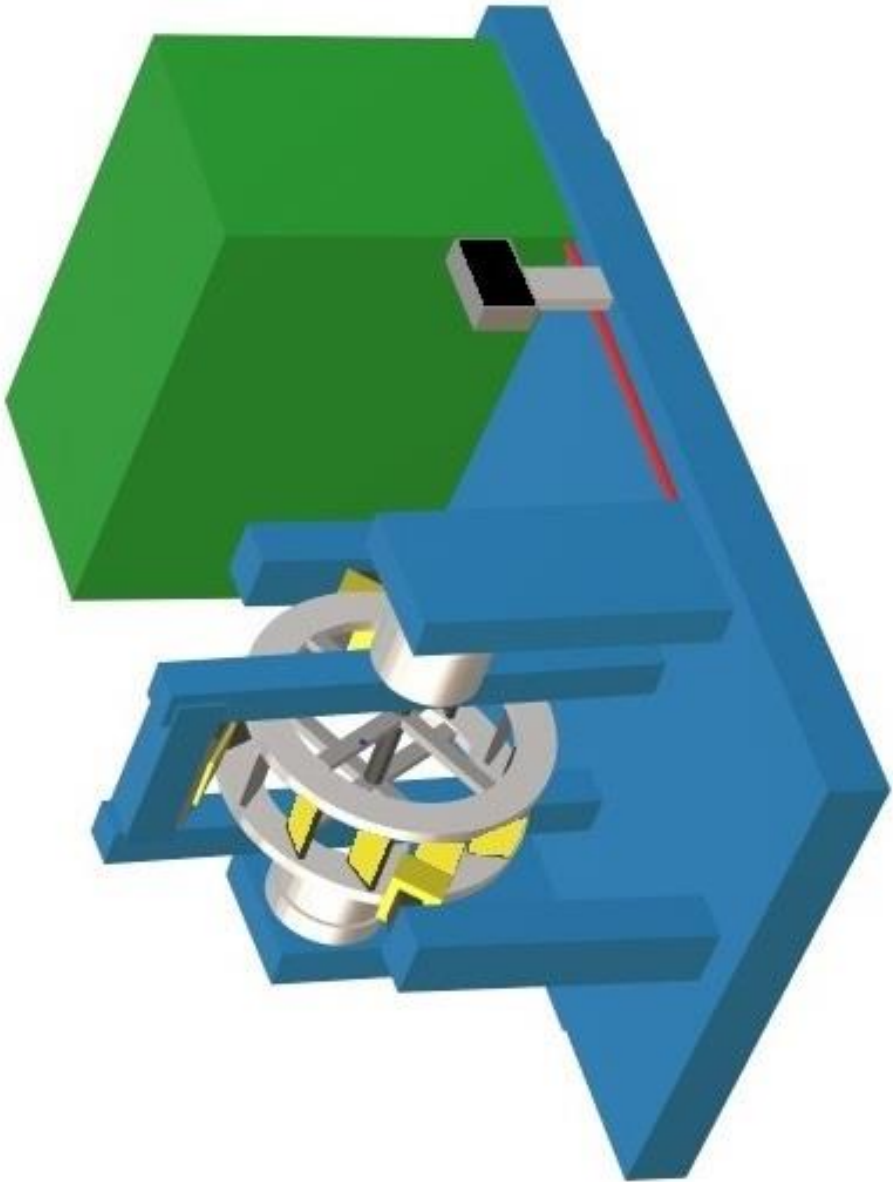

26.3 - 4 Looper Engine Free Energy Machine

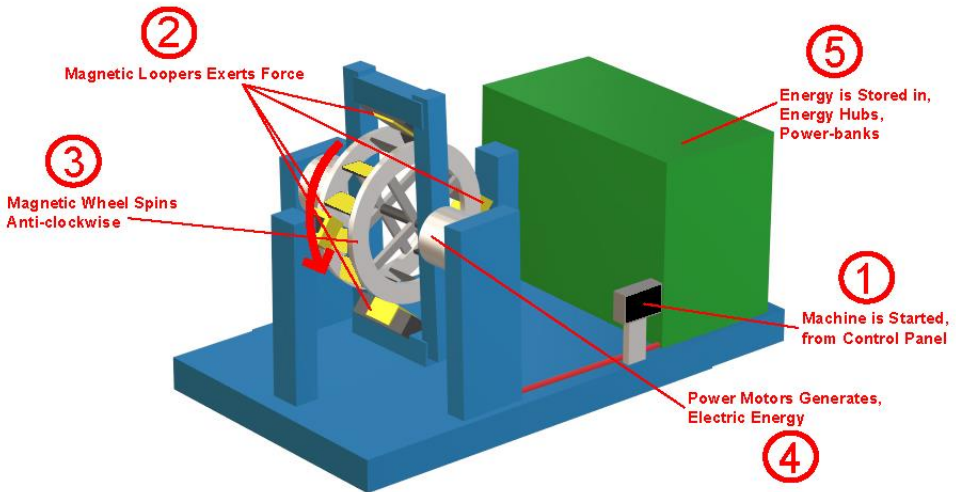
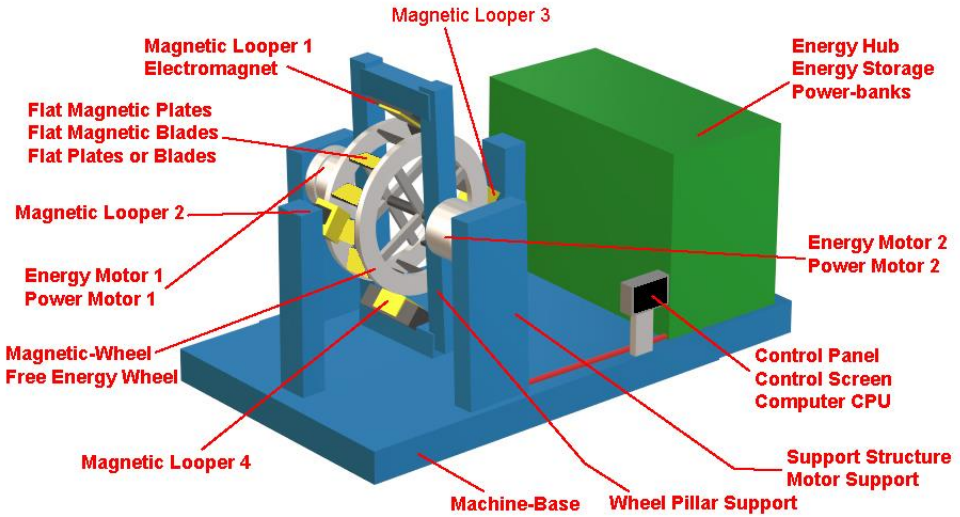

26.4 - 4 Looper Engine Free Energy Machine in-action elaboration

In the first step, the free energy engine and the machine are started from the control panel.

Then all 4 Magnetic Loopers or Electromagnets are activated, which starts exerting the magnetic force to the Magnetic Wheel's Magnetic Flat Plates or Blades in a preconfigured and systematic way, and that makes the Magnetic Wheel Spin in an Anti-clockwise direction.

Keep in mind that the Magnetic Loopers or Electromagnets will have the same magnetic charge on the exposed sides as of the exposed sides of Magnetic Flat Plates or Blades, for creating a magnetic repulsion.

The 4 Magnetic Loopers or Electromagnets can be configured to exert or activate at certain timing with Magnetic Wheel or Free Energy Wheel one by one or else all at

once, they should also be configured in such a manner that if any one of the Magnetic Looper or Electromagnet stops working then the remaining Magnetic Loopers will keep on working smoothly, and the power must cut-off automatically for the non-working Magnetic Loopers.

Upon the Spinning of the Magnetic Wheel or Free Energy Wheel, the Power Motors on both sides of the Wheel start generating electric power, because both the motors are attached to the Magnetic Wheel or Free Energy Wheel.

Finally, the electric power that is generated by the motors is stored in the Power-banks that are inside the Energy Hubs.

The whole process and action keep on repeating until stopped, thus, an infinite and predetermined electric energy is created and stored.

26.5 - 4 Looper Engine Free Energy Machine model pictures.

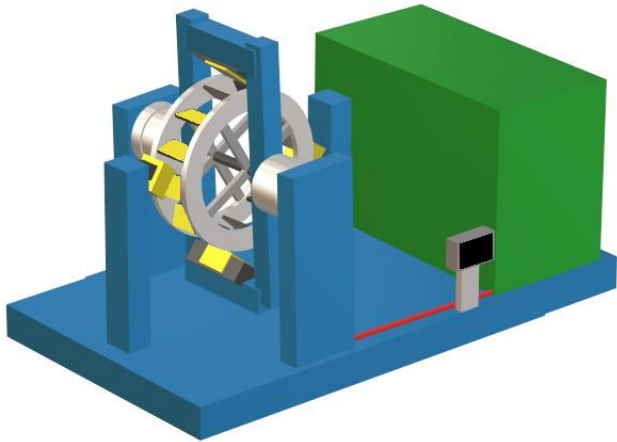
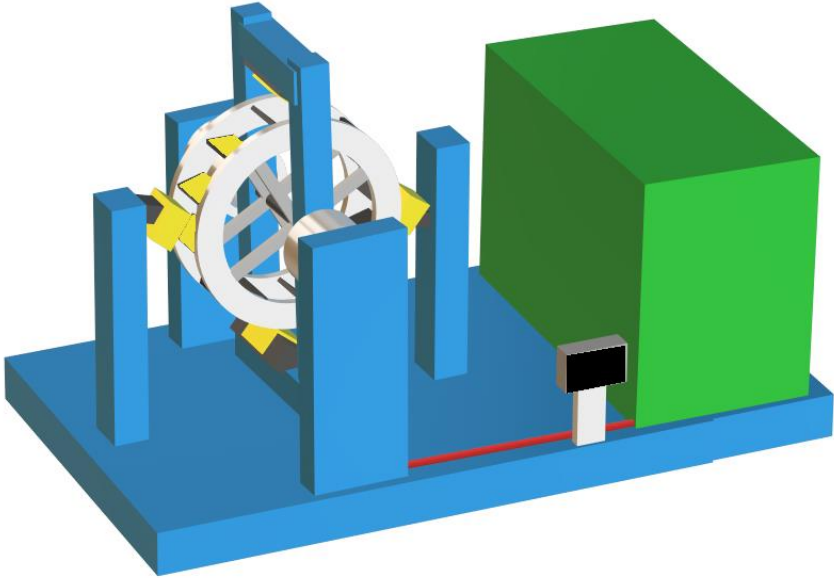

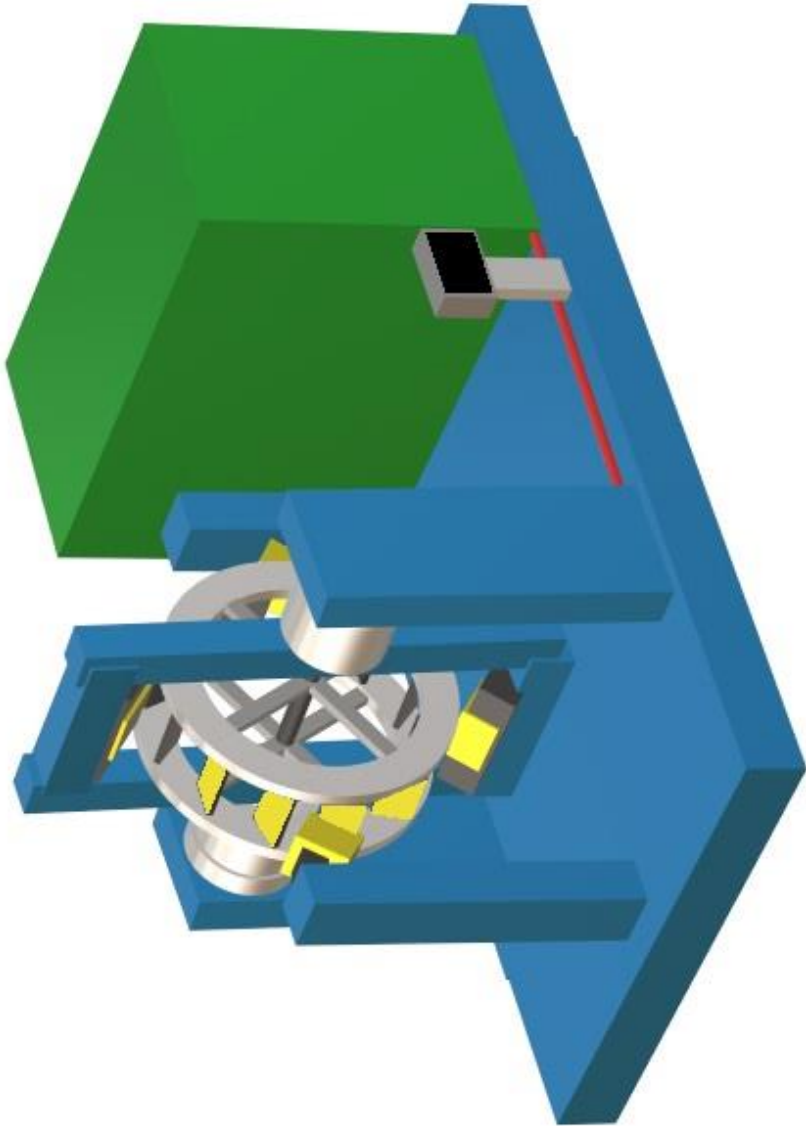

26.6 - 2 Wheels, 1 Looper Engine Free Energy Machine

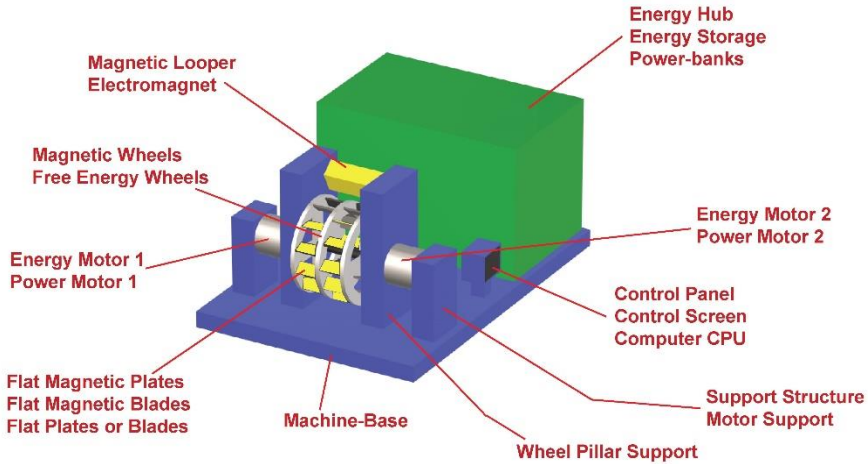

26.7 - 3 Wheels, 1 Looper Engine Free Energy Machine

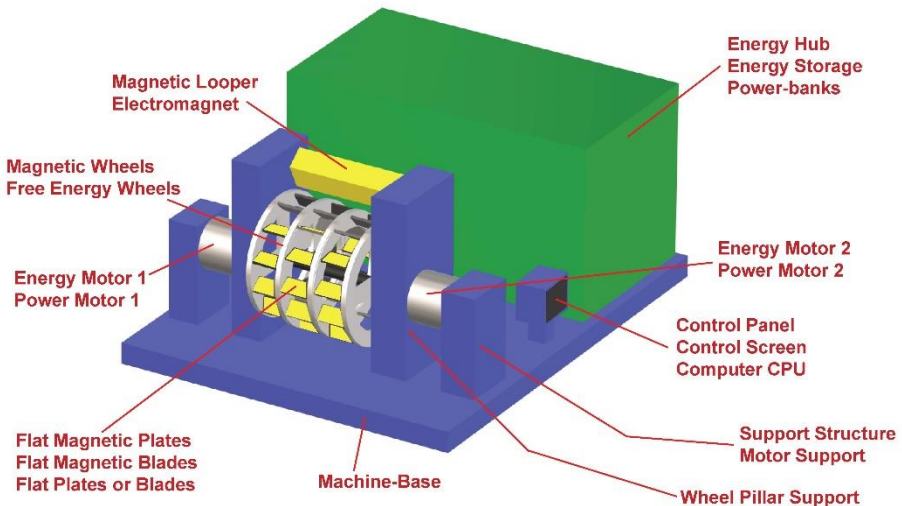

26.8 - 2 and 3 Wheels, 1 Looper Engine Free Energy Machine in-action elaboration

In the first step, the free energy engine and the machine are started from the control panel.

Then Magnetic Looper(s) or Electromagnet(s) are activated, which starts exerting the magnetic force to each Magnetic Wheel's Magnetic Flat Plates or Blades in a preconfigured and systematic way, and that makes the Magnetic Wheel Spin in an Anti-clockwise direction.

Keep in mind that the Magnetic Looper(s) or Electromagnet(s) will have the same magnetic charge on the exposed sides as of the exposed sides of Magnetic Flat Plates or Blades, for creating a magnetic repulsion.

If more than one Magnetic Loopers or Electromagnets then they can be configured to exert or activate at certain timing with Magnetic Wheels or Free

Energy Wheels one by one or else all at once, they should also be configured in such a manner that if any one of the Magnetic Loopers or Electromagnets stops working then the remaining Magnetic Loopers will keep on working smoothly, and the power must cut-off automatically for the non-working Magnetic Loopers.

Upon the Spinning of the Magnetic Wheels or Free Energy Wheels, the Power Motors on both sides of the Wheels start generating electric power, because both the motors are attached to the Magnetic Wheels or Free Energy Wheels.

Finally, the electric power that is generated by the motors is stored in the Power-banks that are inside the Energy Hubs.

The whole process and action keep on repeating until stopped, thus, an infinite and predetermined electric energy is created and stored.

In the 2 and 3 wheels, 1 looper engines the Free Energy Wheel simultaneously spins at a constant and rapid momentum and action, the 2 and 3 wheels might enhance the smoothness by seamlessly spinning the wheel continuously upon the exertion of the electromagnetic force (magnetic looper force). The 2 or 3 wheels are a single unit that has each shaft engraved with magnetic flat plates organized and placed in a zig-zag or 123 formations and alignment and positioning, as one after another. Additional Electromagnets or Magnetic Loopers can be added to the 2 and 3 wheel Engines, and additional wheels can be added instead of 2 and 3 wheels as 4, 5, 6, 7, 8, etc., and 1 large or 1 object or 1 large unit wheel and long wheel with similar shafts can also be created by following the same concepts.

26.9 - 2 Wheels, 1 Loooper Engine Free Energy Machine model pictures

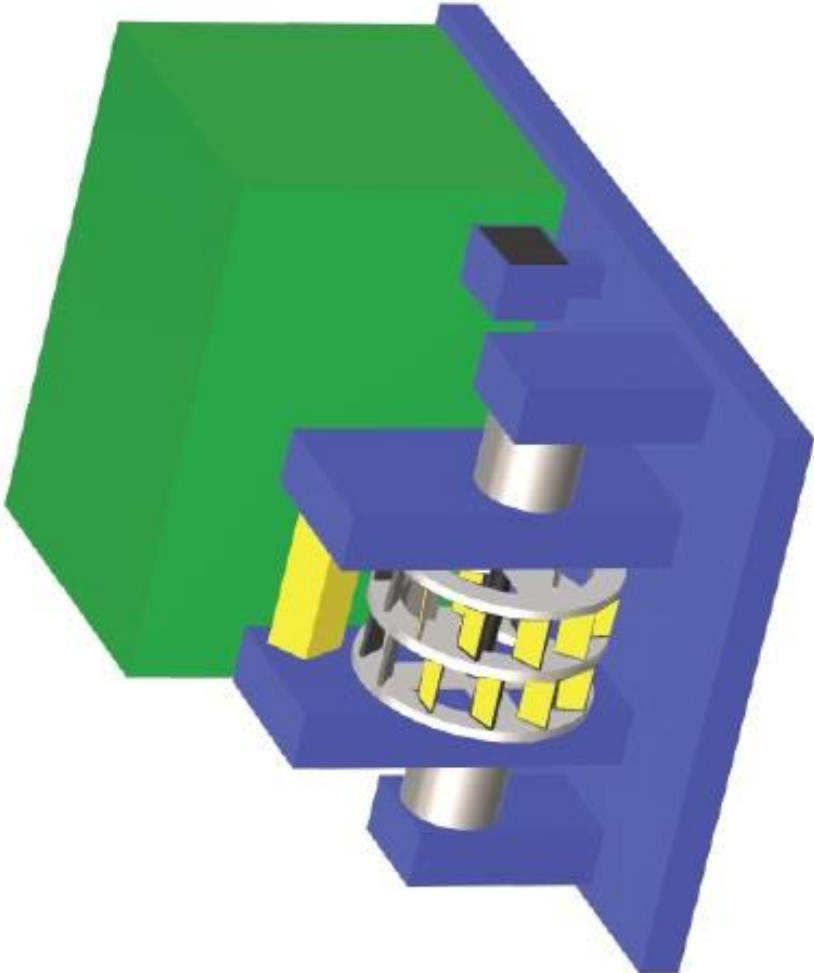

27.0 - 3 Wheels, 1 Looper Engine Free Energy Machine model pictures

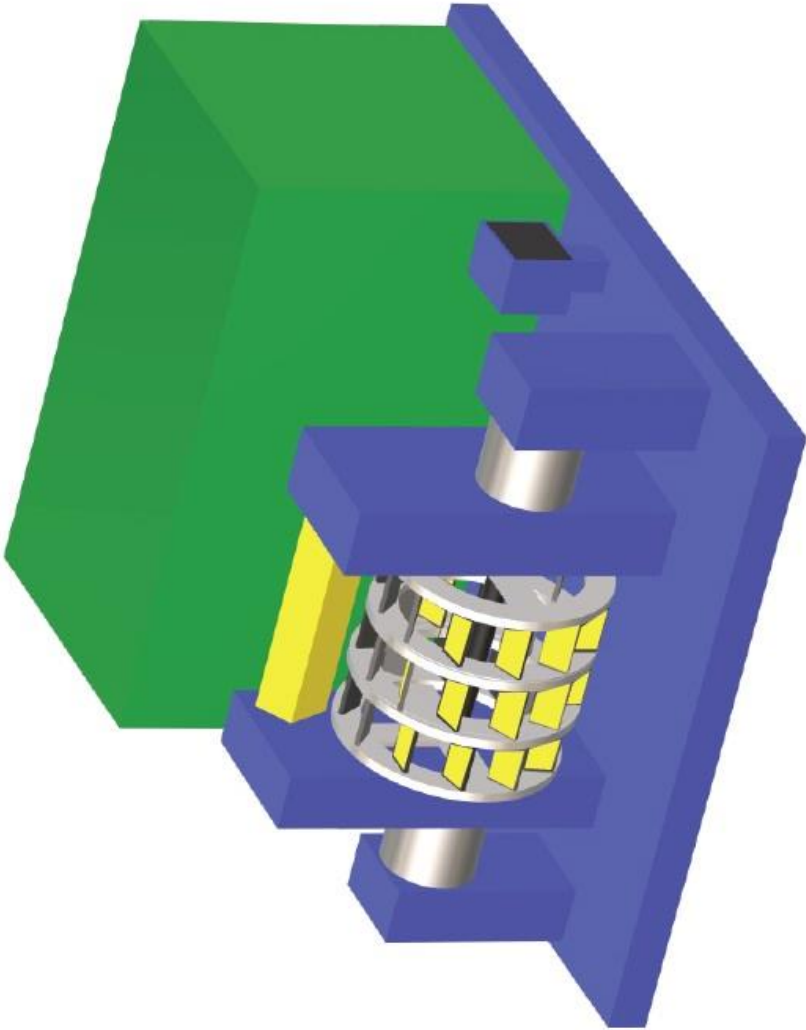

27.1 - Important Free Energy Engine Machine Features

The Magnetic Flat Plates or Blades and Magnetic Wheel Propeller or Magnetic Shafts will be tunable according to the needs, they will have features such as rotation and adjustments according to the desired angle to work with Magnetic Looper properly.

The Magnetic Wheel or Free Energy Wheel will have a feature to make it not move backward or clockwise but locked in an Anti-Clockwise direction.

The Magnetic Wheel or Free Energy Wheel will have a speed control system, for example, the wheel will spin at the desired speed and maintain it, with an internal smart speed control system and breaks that can help maintain the speed in a preconfigured manner.

The Magnetic Looper will become systematically active when the Magnetic

Flat Plates or Blades are in front of the Magnetic Looper and will become Inactive when the Magnetic Flat Plates or Blades are not in front of it, and this process will simultaneously repeat and systematically occur, making the Free Energy Wheel to continuously spin at desired speed, and that can be made possible with a variety of systematic techniques whether mechanical or electronic in coordination with Magnetic Wheel, Magnetic Looper, Magnetic Flat Plates or Blades, and the CPU or Computer System and Energy Power Storage.

The Magnetic Looper or Electromagnet can have its rechargeable battery or batteries inside the Energy Hub Compartment that will get recharged from the Power-banks inside the Energy Hubs, and an extra rechargeable power system can be made for Magnetic Loopers or else the Magnetic Looper or Electromagnet can be made mechanically with jumpstart features and automatic on and off features according to the predefined mechanical action required.

The Free Energy Wheel will be made of a non-magnetic metal or material so that the electromagnet or magnetic looper won't attract the wheel and make it stop spinning, some mechanical component of this machinery needs to be determined to be made of magnetic materials or non-magnetic ones, and what type of materials to use is entirely based on one's own experimentations and research.

The Electromagnet(s) (Magnetic Looper(s)) and the Free Energy Wheel (That Contains Shafts Engraved with Magnetic Flat Plates) need to be placed at such a distance that the induction heating will not happen or will happen in a harmless and minimal impact. The Free Energy Wheel does not need to spin at super high speed but at an adequate speed that can make the energy motors generate enough storable and stable electric energy. A very high spinning of the Free Energy Wheel may result in induction heating due to magnetic fields and magnetic force that is generated, however, this particular part needs to be researched

and determined properly to come up with correct guidance on the topic. The right speed that is needed must be researched and a proper mechanism, system, and action must be placed according to the instruction in the book Free Source of Energy Technology and this article. The Free Energy Wheel speed maintaining system and brake concept and idea are already given and mentioned inside this project book Free Source of Energy Technology.

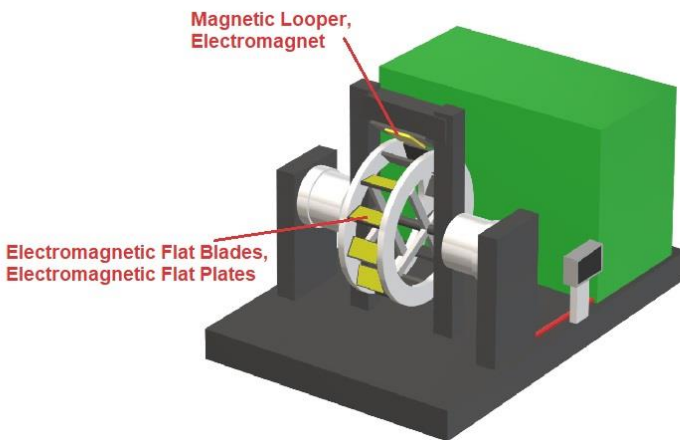

If induction heating is an issue, then another alternative concept and idea is to create the same machine with Electromagnetic Flat Blades or Plates

instead of just Magnetic Flat Blades or Plates that are engraved in Free Energy Wheel's Shafts or Propellers. The Electromagnetic Flat Blades or Plates will become active when the Magnetic Looper is facing them or come in contact and will become inactive when not in contact with the Magnetic Looper. The Electromagnetic Blades or Plates and Magnetic Looper will become active together in coordination and correct preconfigured systematic way, for example, upon the activation of Electromagnetic Flat Blades the Magnetic Looper (Electromagnetic Looper or Corresponding Electromagnet) will become active and vice versa in a timely manner, It is to note that their activation maybe delayed a bit with each for correct adjustment and smoothness required, for example in some scenarios the Electromagnetic Flat Blades or Plates will become active a bit earlier than the Magnetic Looper (Electromagnetic Looper or Electromagnet) followed by the activation of Magnetic Looper and vice versa the Magnetic Looper may start and

activate a bit earlier. An Electromechanical System can be placed in variety of ways for making this process happen.



27.2 - About Author

Syed Mohammad Ahmed is the author of this book “Free Source of Energy Technology” he is a Pakistan National born and brought up in the Abu Dhabi city of United Arab Emirates, and his passions are Technology, Startups, Business, Finance and E-commerce, and Education.

Website: www.freesourceofenergy.com

Website: www.innovatorahmed.com

27.3 Book Summary

Free Source of Energy Technology is the future of the world, this type of technology will revolutionize every business industry and all the existing products and services will be upgraded and made compatible with the Free Energy Technologies.

Free Energy Technology will help save the world from the anticipated and devastating events of Global Warming, Climate Change, Air Pollution, and the nearby Oil and Energy Crisis.

In the future, the products and services and the industries concerned with the making of electronics, automotive, marine, and heavy machinery will start producing those items that will have a built-in power source known as the Free Energy Technology.

Powerplants, such as nuclear, wind, dams, and solar will become an obsolete and rare backup mode due to the innovation of Free

Source of Energy Concepts Technologies.

Not only the Real Estate Sector but all the other sectors and cities and nations around the world will move onto the more safe, clean, and reliable sources of energy such as the Free Energy Technologies.

Electric Power will become the most inexpensive utility; thus, every household will not be worrying about the monthly or annual electric utility bills.

All the poor nations around the globe that lack the power connection will soon become economic power houses and will have infinite electric energy-generating power plants due to the innovations of Free Source of Energy Technologies and Concepts.

In the next 50 years or so the global oil resources will drastically decline and will become a scarce resource; thus, the energy crisis can take its toll on every nation around the globe, but due to the

incredible innovation of Free Energy Technologies, the future events of oil and energy crisis will no longer be big trouble and will be mitigated due to Free Energy Technologies and inventions.

Global Air pollution will be eliminated due to Free Energy Technologies because the automotive industries and transportation sectors around the globe will adapt the Free Energy Concepts and Technologies; thus, modern vehicles will no longer be using fossil fuel as power.

The Free Energy Concepts and Technologies will save every household and business industry around the globe, thousands of dollars which otherwise be spent on Electricity Bills.

Free Source of Energy Concepts and Technologies will affect and dynamically change the multi-trillion-dollar industries around the globe and will save the planet from anticipated and life-threatening events such as global warming, air pollution, and

oil and energy crisis.

Free Source of Energy Technologies will affect the global oil and gas and natural resource markets negatively and positively, as no one will be utilizing them, and they soon will be a scarce resource, but they can be stored and kept saved from consumption.

27.4 – Index

Number of people in the world:

<https://www.worldometers.info/world-population/>

Net Consumption of Electricity Worldwide from 1980 to 2017:

<https://www.statista.com/statistics/280704/world-power-consumption/>

Electricity generation:

https://en.wikipedia.org/wiki/Electricity_generation

World energy consumption:

https://en.wikipedia.org/wiki/World_energy_consumption

World Energy Expenditures:

<https://www.enerdata.net/publications/executive-briefing/world-energy-expenditures.html>

The Global Industry Classification Standard (GICS):

<https://www.msci.com/gics>

Global Gross Domestic Product (GDP) at Current Prices from 2009 to 2021:

<https://www.statista.com/statistics/268750/global-gross-domestic-product-gdp/>

GDP (Current US\$) World Bank National Accounts Data, and OECD National Accounts data files:

<https://data.worldbank.org/indicator/NY.GDP.MKTP.CD>

Gross World Product:

<http://statisticstimes.com/economy/gross-world-product.php>

Trends in global export volume of trade in goods from 1950 to 2018:

<https://www.statista.com/statistics/264682/worldwide-export-volume-in-the-trade-since-1950/>

Bunker Fuel Market Overview:

<https://www.alliedmarketresearch.com/bunker-fuel-market>

List of countries by electricity consumption:

https://en.wikipedia.org/wiki/List_of_countries_by_electricity_consumption

Global electricity prices in 2018, by select country:

<https://www.statista.com/statistics/263492/electricity-prices-in-selected-countries/>

Access to electricity (% of population):

<https://data.worldbank.org/indicator/EG.ELC.ACCS.ZS>

Average Electric Bills in the U.S:

<https://financeguru.com/news/average-electric-bill/>

Economics of Nuclear Power:

<https://www.world-nuclear.org/information-library/economic-aspects/economics-of-nuclear-power.aspx>

Why nuclear power plants cost so much—and what can be done about it:

<https://thebulletin.org/2019/06/why-nuclear-power-plants-cost-so-much-and-what-can-be-done-about-it/>

How much do wind turbines cost?:

http://www.windustry.org/how_much_do_wind_turbines_cost

Wind power in the United States:

https://en.wikipedia.org/wiki/Wind_power_in_the_United_States

Just How Big Is The Oil Market?:

<https://oilprice.com/Energy/Crude-Oil/The-Oil-Market-Is-Bigger-Than-All-Metal-Markets-Combined.html>

Oil left in the world:

<https://www.worldometers.info/oil/>

When will fossil fuels run out?:

<https://www.ecotricity.co.uk/our-green-energy/energy-independence/the-end-of-fossil-fuels>

Electricity generation:

https://en.wikipedia.org/wiki/Electricity_generation

Global Air Conditioners Market By Product Type.....
Competition Forecast & Opportunities, 2013 - 2023:

<https://www.techsciresearch.com/report/global-air-conditioners-market/3709.html>

Heatwave effect: 2.5 billion people to have air conditioners by 2050:

<https://www.downtoearth.org.in/news/climate-change/heatwave-effect-2-5-billion-people-to-have-air-conditioners-by-2050-65948>

Population without access to an AC, including potential access in a Cooling for All scenario, 1990-2100:

<https://www.iea.org/data-and-statistics/charts/population-without-access-to-an-ac-including-potential-access-in-a-cooling-for-all-scenario-1990-2100>

Helping a warming world to keep cool:

<https://www.iea.org/commentaries/helping-a-warming-world-to-keep-cool>

Metal Cutting Machine Market Size, Share & Trends Analysis Report By Region, And Segment Forecasts, 2020 - 2027:

<https://www.grandviewresearch.com/industry-analysis/metal-cutting-machine-market>

\$1 Billion Global Packaging Industry to 2021 - Growing Demand for FMCG and Pharmaceutical Packaging Presents Opportunities:

<https://www.globenewswire.com/news-release/2020/05/12/2031745/0/en/1-Billion-Global-Packaging-Industry-to-2021-Growing-Demand-for-FMCG-and-Pharmaceutical-Packaging-Presents-Opportunities.html>

Global automotive industry revenue between 2017 and 2030:

<https://www.statista.com/statistics/574151/global-automotive-industry-revenue/>

Number of cars sold worldwide between 2010 and 2020:

<https://www.statista.com/statistics/200002/international-car-sales-since-1990/>

Motor vehicle:

https://en.wikipedia.org/wiki/Motor_vehicle

Are we running out of oil?:

<https://www.e-education.psu.edu/eme801/node/486>

Largest automobile factories of the world:

<https://auto.economictimes.indiatimes.com/slideshows/largest-automobile-factories-of-the-world/71149409>

Top 5 Automotive Manufacturing Plants:

<https://www.automotive-iq.com/powertrain/articles/top-5-automotive-manufacturing-plants>

7 of the World's Largest Manufacturing Plants:

<https://www.popularmechanics.com/technology/infrastructure/g2904/7-of-the-worlds-largest-manufacturing-plants/>

What machines are used to make cars?:

<https://www.quora.com/What-machines-are-used-to-make-cars>

Consumer Electronics (worldwide):

<https://www.statista.com/outlook/251/100/consumer-electronics/worldwide>

CONSUMER ELECTRONICS MARKET SIZE BY PRODUCT (AUDIO & VIDEO EQUIPMENT [PERSONAL, PROFESSIONAL], MAJOR:

<https://www.gminsights.com/industry-analysis/consumer-electronics-market>

Global Consumer Electronics Market Worth \$838.85 Billion By 2020:

<https://www.grandviewresearch.com/press-release/global-consumer-electronics-market>

Global Consumer Electronics Market Will Reach USD 1,787 Billion by 2024: Zion Market Research:

<https://www.globenewswire.com/news-release/2018/06/29/1531798/0/en/Global-Consumer-Electronics-Market-Will-Reach-USD-1-787-Billion-by-2024-Zion-Market-Research.html>

Total revenue of the global toy market from 2007 to 2019:

<https://www.statista.com/statistics/194395/revenue-of-the-global-toy-market-since-2007/>

Toys Market - Global Outlook and Forecast 2018-2023:
<https://www.researchandmarkets.com/reports/4655482/toys-market-global-outlook-and-forecast-2018>

Global Sales Data: Global toy sales reached \$90.7 billion in 2019, posting a 0.5% growth over 2018:
<https://www.toyassociation.org/ta/research/data/global/toys/research-and-data/data/global-sales-data.aspx>

Power and Hand Tools Market: Industry Perspective, Comprehensive Analysis and Forecast, 2015 – 2021:
<https://www.zionmarketresearch.com/report/power-and-hand-tools-market>

Global Power Tools Industry:
<https://www.globenewswire.com/news-release/2020/08/31/2085876/0/en/Global-Power-Tools-Industry.html>

Global Power Tools - Demand and Sales Forecasts, Market Share, Market Size, Market Leaders:
<https://www.freedoniagroup.com/World-Power-Tools.html>

Progress in least developed countries hinges on access to modern energy:
<https://unctad.org/en/pages/newsdetails.aspx?OriginalVersionID=1608>

General Lighting Global Market Report 2020:
<https://www.thebusinessresearchcompany.com/report/general-lighting-global-market-report>

LED Lighting Market Size & Share, Industry Report, 2020-2027:

<https://www.grandviewresearch.com/industry-analysis/led-lighting-market>

LED Lighting Market Size Worth \$127.04 Billion By 2027:

<https://www.grandviewresearch.com/press-release/global-led-lighting-market>

What Is Light Poverty?: How Sustainable Lighting Can End It:

<http://www.ciralight.com/blog/what-is-light-poverty-how-do-we-stop-it>

In the International Year of Light, we can end light poverty:

<https://www.philips.com/a-w/about/news/archive/blogs/innovation-matters/in-the-international-year-of-light-we-can-end-light-poverty.html>

One-Quarter of World's Population Lacks Electricity:

<https://www.scientificamerican.com/article/electricity-gap-developing-countries-energy-wood-charcoal/>

Blackout: 1 Billion Live Without Electric Light:

<https://business.time.com/2013/09/05/blackout-1-billion-live-without-electric-light/>

What share of people have access to electricity?:
<https://ourworldindata.org/energy-access#access-to-electricity>

World Bank and WHO: Half the world lacks access to essential health services, 100 million still pushed into extreme poverty because of health expenses:
<https://www.who.int/news-room/detail/13-12-2017-world-bank-and-who-half-the-world-lacks-access-to-essential-health-services-100-million-still-pushed-into-extreme-poverty-because-of-health-expenses>

Global Portable Medical Devices Industry:
<https://www.globenewswire.com/news-release/2020/09/25/2099463/0/en/Global-Portable-Medical-Devices-Industry.html>

Developing Countries Lead the Way in Mobile-Health Technologies:
<https://healthmarketinnovations.org/blog/developing-countries-lead-way-mobile-health-technologies>

Reviewing mHealth in Developing Countries: A Stakeholder Perspective:
<https://www.sciencedirect.com/science/article/pii/S1877050916324450>

68% of the world population projected to live in urban areas by 2050, says UN:

<https://www.un.org/development/desa/en/news/population/2018-revision-of-world-urbanization-prospects.html>

There are 10,000 Cities on Planet Earth. Half Didn't Exist 40 Years Ago:

<https://nextcity.org/daily/entry/there-are-10000-cities-on-planet-earth-half-didnt-exist-40-years-ago>

Developments and Forecasts on Continuing Urbanization:

https://ec.europa.eu/knowledge4policy/foresight/topic/continuing-urbanisation/developments-and-forecasts-on-continuing-urbanisation_en

HUD'S PROPOSED 2021 BUDGET:

<https://www.hud.gov/budget>

Guide to LED Street Lights:

<https://www.ledlightingsupply.com/blog-the-complete-guide-to-led-roadway-lights>

Elevator Market - Forecast(2020 - 2025):

<https://www.industryarc.com/Report/18097/elevator-market.html>

ELEVATOR MARKET SIZE BY PRODUCT (HYDRAULIC & PNEUMATIC, MACHINE ROOM [MR] TRACTION, MACHINE ROOM-LES:

<https://www.gminsights.com/industry-analysis/elevator-market>

Projected market size for heating, ventilation, and air conditioning (HVAC) worldwide from 2019 to 2030:

<https://www.statista.com/statistics/414960/global-market-for-commercial-and-residential-hvac-systems/>

Global Telecom Services Market Size & Share Report, 2020-2027:

<https://www.grandviewresearch.com/industry-analysis/global-telecom-services-market>

Global Telecoms Market:

<https://www.thebusinessresearchcompany.com/report/elecoms-market>

Telecom Towers Market:

<https://www.verifiedmarketresearch.com/product/global-telecom-towers-market-size-and-forecast-to-2025/>

TRAFFIC MANAGEMENT MARKET:

<https://www.marketsandmarkets.com/Market-Reports/traffic-management-market-1036.html>

Real Estate Market Expected to Reach \$8.6 Trillion by 2026:

<https://www.alliedmarketresearch.com/press-release/real-estate-market.html>

Market Size Report on Global Real Estate, How has the global real estate investment market evolved in 2019?:

<https://www.msci.com/real-estate/market-size-report>

Global Passenger Air Transport Market Forecasts to 2030 - Projected to Grow at a Revised CAGR of 8%

During 2021-2023 due to COVID-19, to Reach \$765 Billion by 2023:

<https://www.prnewswire.com/news-releases/global-passenger-air-transport-market-forecasts-to-2030---projected-to-grow-at-a-revised-cagr-of-8-during-2021-2023-due-to-covid-19-to-reach-765-billion-by-2023-301083593.html>

Aviation Fuel Market:

<https://www.alliedmarketresearch.com/aviation-fuel-market#>

Global Aviation Fuel Market to Reach \$238.5 Billion by 2026:

<https://www.globenewswire.com/news-release/2020/06/17/2049621/0/en/Global-Aviation-Fuel-Market-to-Reach-238-5-Billion-by-2026-AMR.html>

World Aerospace Market Study 2020-2030 with COVID-19 Adjusted Analyses and Forecasts:

<https://www.prnewswire.com/news-releases/world-aerospace-market-study-2020-2030-with-covid-19-adjusted-analyses-and-forecasts-301080928.html>

Global automotive industry revenue between 2017 and 2030

<https://www.statista.com/statistics/574151/global-automotive-industry-revenue/>

The global automotive motors market size is projected to grow from USD 20,321 million in 2020 to USD 25,719 million by 2025, at a CAGR of 4.8%:

<https://www.prnewswire.com/news-releases/the-global-automotive-motors-market-size-is-projected-to-grow->

from-usd-20-321-million-in-2020-to-usd-25-719-million-by-2025--at-a-cagr-of-4-8-301113089.html#

Marine Vessel Market Size, Share and Industry Analysis, by Type, and Regional Forecast, 2019 - 2026:
<https://www.fortunebusinessinsights.com/marine-vessel-market-102699>

Marine Vessels Market Size to Reach USD 220.18 Billion by 2026:
<https://www.globenewswire.com/news-release/2020/05/05/2027359/0/en/Marine-Vessels-Market-Size-to-Rreach-USD-220-18-Billion-by-2026-Increasing-Emphasis-on-Technological-Integration-to-Aid-Growth-says-Fortune-Business-Insights.html#>

Size of the global shipbuilding market in 2018 with a forecast for 2019 to 2025:
<https://www.statista.com/statistics/1102252/size-of-the-global-shipbuilding-market/#>

Bunker Fuel Market by Type, Global Opportunity Analysis and Industry Forecast, 2018 - 2025
<https://www.alliedmarketresearch.com/bunker-fuel-market#>

The global marine port and service market is expected to reach an estimated \$87.8 billion by 2023 and it is forecast to grow at a CAGR of 4.2% from 2018 to 2023:
<https://www.prnewswire.com/news-releases/the-global-marine-port-and-service-market-is-expected-to-reach-an-estimated-87-8-billion-by-2023-and-it-is-forecast-to-grow-at-a-cagr-of-4-2-from-2018-to-2023--300701136.html>

Global Ocean Freight Forwarding Market 2020 Top Companies report covers, Industry Outlook | In-depth Analysis Business Opportunities and Showing Impressive Growth by 2026:

<https://www.marketwatch.com/press-release/global-ocean-freight-forwarding-market-2020-top-companies-report-covers-industry-outlook-in-depth-analysis-business-opportunities-and-showing-impressive-growth-by-2026-2020-08-17#>

Ocean Freight Forwarding Market By Products (Full Container Load And Less-Than Container Load) And Regions (Asia Pacific, North America, Latin America, Europe, And Middle East & Africa) – Global Industry Analysis, Growth, Share, Size, Trends And Forecast 2020 – 2026:

<https://dataintelo.com/report/ocean-freight-forwarding-market/>

Global Heavy Construction Equipment Market to Reach \$240.49 Billion by 2027: AMR:

<https://www.globenewswire.com/news-release/2020/08/24/2082696/0/en/Global-Heavy-Construction-Equipment-Market-to-Reach-240-49-Billion-by-2027-AMR.html>

Heavy Construction Equipment Market:

<https://www.alliedmarketresearch.com/heavy-construction-equipment-market>

Global market size of smart farming 2017-2022:

<https://www.statista.com/statistics/720062/market-value-smart-agriculture-worldwide/#>

Agriculture and Food:

<https://www.worldbank.org/en/topic/agriculture/overview>

Agriculture, forestry, and fishing, value added (current US\$):

<https://data.worldbank.org/indicator/NV.AGR.TOTL.CD>

Global Commercial Fishing Industry Market to 2026 - Exhaustion of Marine Resources are Inhibiting Market Growth:

<https://www.prnewswire.com/news-releases/global-commercial-fishing-industry-market-to-2026---exhaustion-of-marine-resources-are-inhibiting-market-growth-300791788.html>

Global seafood market value 2019-2027:

<https://www.statista.com/statistics/821023/global-seafood-market-value/>

Global Fish and Seafood Market Is Expected to Reach USD 206.89 Billion by 2026:

<https://www.globenewswire.com/news-release/2020/02/27/1991708/0/en/global-fish-and-seafood-market-is-expected-to-reach-usd-206-89-billion-by-2026-for-markets.html>

Fish Farming Market:

<https://www.alliedmarketresearch.com/fish-farming-market>

Global Courier Services Market Size 2020 Trend and Opportunities, Market Share, Analysis, CAGR and Value Chain Study, Showing Impressive Growth by 2026:

<https://www.marketwatch.com/press-release/global-courier-services-market-size-2020-trend-and-opportunities-market-share-analysis-cagr-and-value-chain-study-showing-impressive-growth-by-2026-2020-09-12>

Online Food Delivery:

<https://www.statista.com/outlook/374/100/online-food-delivery/worldwide>

Global Online Food Delivery Services Market (2020 to 2030) - COVID-19 Growth and Change - ResearchAndMarkets.com:

<https://www.businesswire.com/news/home/20200511005687/en/Global-Online-Food-Delivery-Services-Market-2020-to-2030---COVID-19-Growth-and-Change---ResearchAndMarkets.com#>

Total retail sales worldwide from 2018 to 2022:

<https://www.statista.com/statistics/443522/global-retail-sales/>

Market size of the global hotel industry from 2014 to 2018:

<https://www.statista.com/statistics/247264/total-revenue-of-the-global-hotel-industry/>

Global Educational Services Market Report 2020-30:
COVID-19 Impact and Recovery -
ResearchAndMarkets.com:
<https://www.businesswire.com/news/home/20200529005211/en/Global-Educational-Services-Market-Report-2020-30-COVID-19-Impact-and-Recovery---ResearchAndMarkets.com>

Car Emissions and Global Warming:
<https://www.ucsusa.org/resources/car-emissions-global-warming>

Basic Ozone Layer Science:
<https://www.epa.gov/ozone-layer-protection/basic-ozone-layer-science#self>

Air pollution in India:
https://en.wikipedia.org/wiki/Air_pollution_in_India#

Emissions worldwide - Statistics & Facts:
<https://www.statista.com/topics/5770/global-greenhouse-gas-emissions/#>

Air pollution:
https://www.who.int/health-topics/air-pollution#tab=tab_1

List of pollution-related diseases:
https://en.wikipedia.org/wiki/List_of_pollution-related_diseases

Death rates from air pollution, World, 1990 to 2017:
<https://ourworldindata.org/grapher/death-rate-by-source-from-air-pollution>

Effects of Global Warming:
<https://www.livescience.com/37057-global-warming-effects.html>

The Effects of Climate Change:
<https://climate.nasa.gov/effects/>

Global Warming 101:
<https://www.nrdc.org/stories/global-warming-101>

How climate change plunders the planet
<https://www.edf.org/climate/how-climate-change-plunders-planet>:

Main sources of carbon dioxide emissions:
<https://www.che-project.eu/news/main-sources-carbon-dioxide-emissions#>:



Note Page 1

This page is intentionally left blank for notetaking by the readers.

Note Page 2

This page is intentionally left blank for notetaking by the readers.

Don't cut or pull from here!



Bookmark / Reminder



Bookmark / Reminder



Bookmark / Reminder



Bookmark / Reminder



Bookmark / Reminder



Bookmark / Reminder

This page is intentionally left blank